



RF & MICROWAVE COMPONENTS



PPI



High-Q, Low ESR Multi-Layer Ceramic Capacitors
High-Q High Voltage Custom Assemblies

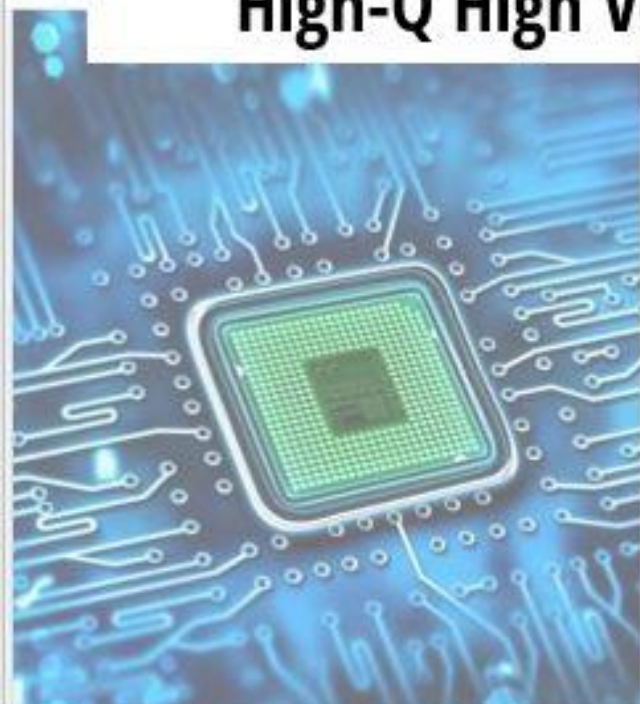



Traditional High Q (>10,000) Low ESR Multi-Layer Ceramic Capacitors

Passive Plus, Inc. (PPI) specializes in Magnetic & Non-Magnetic HI-Q Components, supplying reliable quality components to the Aerospace, Telecommunications, Medical Semiconductor, and Military industries.

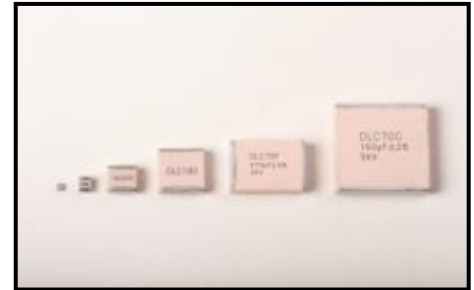

*Marking shown for illustration purposes only.
Actual marking may differ.*

PPI is an American (New York), Woman owned Business.

- PPI is ISO9001:2015 certified.
- S level reliability
- Mil C 55681
- Mil C 123
- EAR 99 Compliant
- No ITAR Issues
- Export Compliant
- RoHS and REACH Compliant

PPI has been audited by some of the largest and most successful companies in the world and has received extremely high audit ratings. We believe our audit ratings are best in class. PPI is known for Outstanding Customer Service and RF Engineering Support.



Traditional High Q (>10,000) Low ESR Multi-Layer Ceramic Capacitors

Product Features

- High Q
- High Power
- Low ESR/ESL
- Low Noise
- High Self-Resonance
- Ultra Stable Performance

Product Applications

Typical Functional Applications:

- Tuning • Bypass • Coupling
- Feedback • D.C. Blocking
- Impedance Matching

Typical Circuit Applications:

- UHF/Microwave RF Power Amplifiers •
- Mixers • Oscillators • Filter Networks
- Low Noise Amplifiers • Timing Circuits and Delay Lines

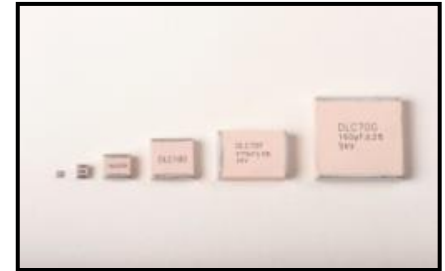

Marking shown for illustration purposes only.
Actual marking may differ.

Part Numbering

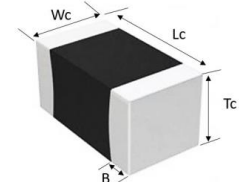
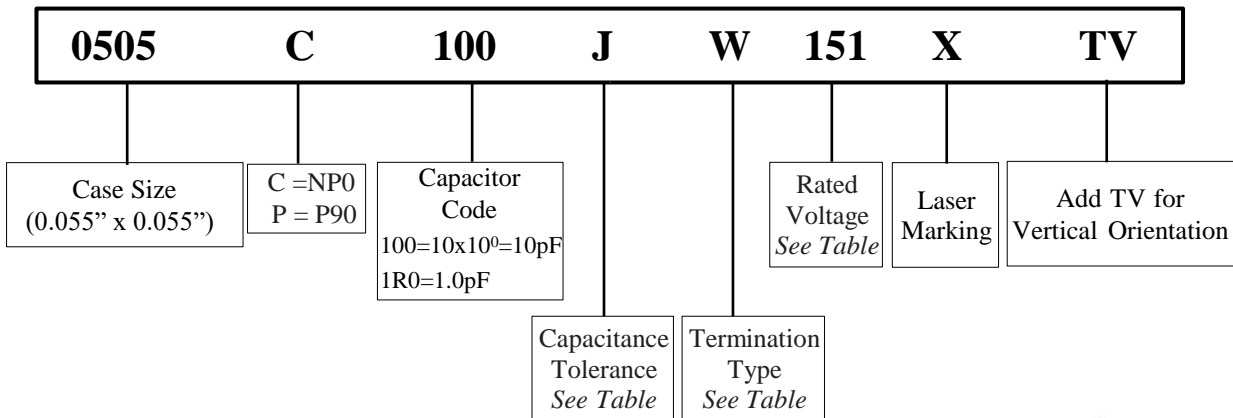

Case Size (Chip) Dimensions

	0505	1111	2225	3838	6040	7676
Length (L_c)	0.055 + 0.015 to -0.010 (1.40 +0.38 to -0.25)	0.110 + 0.020 to -0.010 (2.79 +0.51 to -0.25)	0.225 -0.010+0.25 (5.72 -0.25+ 0.64)	0.380 -0.010+0.015 (9.65 -0.25+0.38)	0.614 -0.010+0.015 (15.6 -0.25+0.38)	0.760 -0.010+0.015 (19.3 -0.25+0.38)
Width (W_c)	0.055 ± .010 (1.40 ±0.25)	0.110 ± 0.010 (2.79 ±0.25)	0.250 ± 0.015 (6.35 ± 0.38)	0.380 ±0.010 (9.65±0.25)	0.433±0.010 (11.0±0.25)	0.760±0.010 (19.3±0.25)
Thickness (T_c)	0.057 (1.45 max)	0.10 (2.54 max)	0.165 (4.19) max	0.170 (4.32) max	0.154±0.008 (3.90±0.20) max	0.154±0.008 (3.90±0.20) max
Overlap (B)	0.02 (0.51max)	0.024 (0.60max)	0.020~0.047 (0.50~1.20) max	0.024~0.059 (0.60~1.50)	0.063 (1.60) max	0.063 (1.60) max



Traditional High Q (>10,000) Low ESR Multi-Layer Ceramic Capacitors

≠ Temperature Coefficient

C: -55°C to 125°C 0±30ppm/°C; >125 °C to 200°C 0±60ppm/°C
P: +90±20ppm/°C

≠ Rated Capacitance

Capacitance is less than 10pF; for example: 1R0=1.0pF, R denotes decimal point

Capacitance greater than 10pF; for example: 101=100pF, the third number is the power of 10

≠ Tolerance

Capacitance Tolerance								
Code	A	B	C	D	F	G	J	K
Tolerance	±0.05pF	±0.1pF	±0.25pF	±0.5pF	±1%	±2%	±5%	±10%

≠ Termination Types and Codes

Magnetic			⊗ Non-Magnetic		
Termination Code	Type	Magnetic Termination	Termination Code	Type	Non-Magnetic Terminations
W	Chip	100% Sn Solder over Nickel Plating	P	Chip	100% Sn Solder over Copper Plating
L	Chip	90% Sn10%Pb Tin/Lead Solder over Nickel Plating	MN	Microstrip	Silver-Plated Copper
MS	Microstrip	Silver-Plated Copper	AN	Axial Ribbon	
AR	Axial Ribbon		FN	Radial Ribbon	
RR	Radial Ribbon		RN	Axial Wire	
RW	Axial Wire		BN	Radial Wire	
AW	Radial Wire				



Traditional High Q (>10,000) Low ESR Multi-Layer Ceramic Capacitors

≠ Voltages

Code	Rated Voltage	Code	Rated Voltage
500	50V	152	1500V
101	100V	202	2000V
151	150V	252	2500V
201	200V	302	3000V
301	300V	362	3600V
501	500V	502	5000V
102	1000V	722	7200V

≠ Laser Marking

An “X” at the end of the part number indicates the part is marked.

≠ Packing Orientation Option

TV: Tape carrier packaging Vertical Orientation.

Vertical orientation means that if the part is lifted from the tape without any rotation and placed on a substrate, its electrodes will be perpendicular to the substrate plane. This impacts the frequency of First Parallel Resonance (suckout).

≠ Performance Requirements

Capacitors are designed and manufactured to meet the requirements of MIL-PRF-55681 and MIL-PRF-123.

All products are in compliance with RoHS instruction. 



Traditional High Q (>10,000) Low ESR
Multi-Layer Ceramic Capacitors

0505C/P (0.055" x 0.055")

≠ Product Features

- High Q
- High Power
- Low ESR/ESL
- Low Noise
- High Self-Resonance
- Ultra Stable Performance
- Capacitance Range:
0.1pF to 1000pF
- Working Voltage: 150V
- Extended Voltage: 300V

≠ Product Applications

Typical Functional Applications:

- Tuning • Bypass • Coupling
- Feedback • D.C. Blocking
- Impedance Matching

Typical Circuit Applications:

- UHF/Microwave RF Power Amplifiers
- Mixers • Oscillators • Filter Networks
- Low Noise Amplifiers • Timing Circuits
and Delay Lines

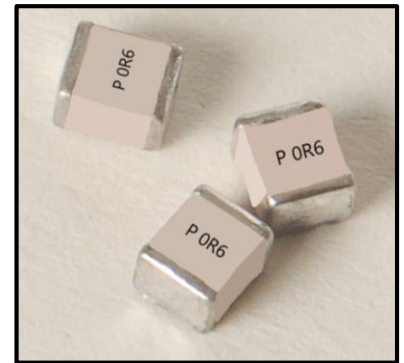

Marking shown for illustration purposes only.
Actual marking may differ.

≠ Part Numbering

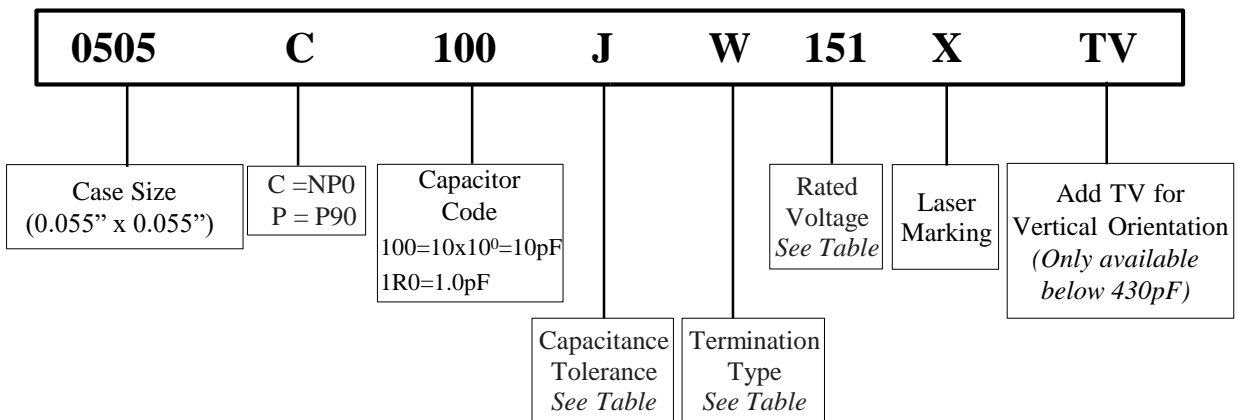

≠ Capacitor Dimensions

Unit: inch (millimeter)

Length	Width	Thickness	Overlap
Lc	Wc	Tc	B
0.055 + 0.015 to -0.010 (1.40 + 0.38 to -0.25)	0.055 ± .010 (1.40 ± 0.25)	0.057 (1.45 max)	0.020 (0.51 max)

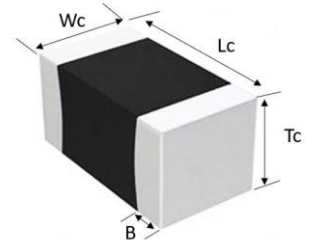

≠ Temperature Coefficient

- C:** -55° to 125°C 0± 30ppm/°C;
>125°C to 200°C 0± 60ppm/°C
- P:** ±90 ±20ppm/°C



Traditional High Q (>10,000) Low ESR
Multi-Layer Ceramic Capacitors

0505C/P (0.055" x 0.055")

≠ 0505C/P Capacitance Values

- NP0=C; P90=P
- **Maximum Capacitance: 0505P=100pF; 0505C=1000pF**
- * - Available in NP0 only.

Special capacitances, tolerances and WVDC are available. Please contact PPI.



Cap. pF	Cap Code	Tol.	Rated WVDC		Cap. pF	Cap Code	Tol.	Rated WVDC		Cap. pF	Cap Code	Tol.	Rated WVDC		Cap. pF	Cap Code	Tol.	Rated WVDC	
			Std.	Ext.				Std.	Ext.				Std.	Ext.				Std.	Ext.
0.1	0R1	A,B, C,D	150V	250V or 300V	2.4	2R4	A,B, C,D	150V	250V or 300V	20	200	F,G, J,K	150V	250V or 300V	160	161*	F,G, J,K	150V	200V
0.2	0R2				2.7	2R7				22	220				180	181*			
0.3	0R3				3.0	3R0				24	240				200	201*			
0.4	0R4				3.3	3R3				27	270				220	221*			
0.5	0R5				3.6	3R6				30	300				240	241*			
0.6	0R6				3.9	3R9				33	330				270	271*			
0.7	0R7				4.3	4R3				36	360				300	301*			
0.8	0R8				4.7	4R7				39	390				330	331*			
0.9	0R9				5.1	5R1				43	430				360	361*			
1.0	1R0				5.6	5R6				47	470				390	391*			
1.1	1R1				6.2	6R2				51	510				430	431*			
1.2	1R2				6.8	6R8				56	560				470	471*			
1.3	1R3				7.5	7R5				62	620				510	511*			
1.4	1R4				8.2	8R2				68	680				560	561*			
1.5	1R5				9.1	9R1				75	750				620	621*			
1.6	1R6	10	100	82	820	680	681*												
1.7	1R7	11	110	91	910	750	751*												
1.8	1R8	12	120	100	101	820	821*												
1.9	1R9	13	130	110	111*	910	911*												
2.0	2R0	15	150	120	121*	1000	102*												
2.1	2R1	16	160	130	131*														
2.2	2R2	18	180	150	151*														

*Available in NP0 only





Traditional High Q (>10,000) Low ESR
Multi-Layer Ceramic Capacitors

0505C/P (0.055" x 0.055")

≠ Capacitance Tolerance Codes

Code	A	B	C	D	F	G	J	K
Tol.	±0.05pF	±0.1pF	±0.25pF	±0.5pF	±1%	±2%	±5%	±10%

≠ Termination Types

Termination Code	Termination
W	100% Sn Solder over Nickel Plating 
L	90% Sn10%Pb Tin/Lead Solder over Nickel Plating
P (Non-Magnetic) 	100%Sn Solder over Copper Plating 

Note: "Non-Magnetic" means no magnetic materials.

≠ Voltage Codes

Voltage	Code
50V	500
100V	101
150V	151
200V	201
250V	251
300V	301





Traditional High Q (>10,000) Low ESR
Multi-Layer Ceramic Capacitors

0505C/P (0.055" x 0.055")

≠ Electrical Specifications

Quality Factor (Q)	Greater than 10,000 at 1 MHz
Insulation Resistance (IR)	10 ⁵ MegaOhms min. @ +25°C rated WVDC 10 ⁴ MegaOhms min. @ +125°C rated WVDC
Rated Voltage	See Rated Voltage Table
Dielectric Withstanding Voltage (WVDC)	250% of Rated Voltage of 5 seconds
Operating Temperature Range	-55°C to 200°C
Temperature Coefficient (TC)	C: -55°C to 125°C 0±30ppm/°C; >125°C to 200°C 0±60ppm/°C P: +90±20ppm/°C
Capacitance Drift	±0.02% or ±0.02pF, whichever is greater
Piezoelectric Effects	None
Termination Type	See Termination Type Table

Capacitors are designed and manufactured to meet the requirements of MIL-PRF-55681 and MIL-PRF-123.

≠ Environmental Specifications

	Specification	Test Parameters
Thermal Shock	DWV: The initial Value IR: Shall not be less than 30% of the initial value. Capacitance Change:	MIL-STD-202, Method 107, Condition A. At the maximum rated temperature (-55°C and 200°C) stay 30 minutes, the time of removing shall not be more than 3 minutes. Perform five cycles.
Moisture Resistance	No more than 0.5% or 0.5pF, whichever is greater.	MIL-STD-202, Method 106
Humidity (Steady State)	DWV: The initial Value IR: The initial value. Capacitance Change: No more than 0.5% or 0.5pF, whichever is greater.	MIL-STD-202, Method 103, Condition A With 1.5Volts DC applied while subjected to an environment of 85°C with 85% relative humidity for 240 hours minimum.
Life	IR: Shall not be less than 30% of the initial value. Capacitance Change: No more than 2.0% or 0.5pF, whichever is greater.	MIL-STD-202, Method 108. For 2000 hours, at 200°C. Rated Voltage DC applies.
Terminal Strength	Force: 10lbs typical, 5lbs. Minimum. Duration Time: 5 to 10 seconds	MIL-STD-202, Method 211A, Test Condition A. Applied a force and maintained for a period of 5 to 10 seconds. The force shall be in the direction of the axes of the terminations.



≠ FPR -- First Parallel Resonance (FPRs)

≠ Definitions and Measurement Conditions

The **First Parallel Resonance, FPR**, is defined as the lowest frequency at which a suckout or notch appears in $|S_{21}|$.

It is generally independent of substrate thickness or dielectric constant, but does depend on capacitor orientation. A horizontal orientation means the capacitor electrode planes are parallel to the plane of the substrate; a vertical orientation means the electrode planes are perpendicular to the substrate.

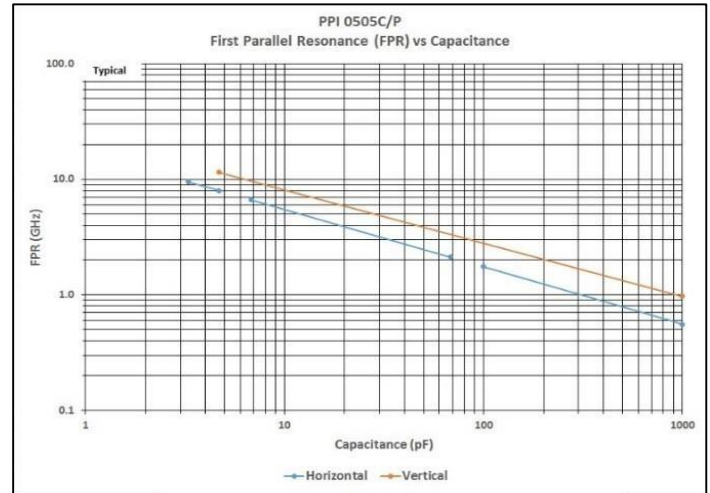

≠ FSR -- First Series Resonance (FSRs)

≠ Definitions and Measurement Conditions

The **First Series Resonance, FSR**, is defined as the lowest frequency at which the imaginary part of the input impedance, $\text{Im}[Z_{in}]$, equals zero. Should $\text{Im}[Z_{in}]$ or the real part of the input impedance, $\text{Re}[Z_{in}]$, not be monotonic with frequency at frequencies lower than those at which $\text{Im}[Z_{in}] = 0$, the FSR shall be considered as undefined (represented as a gap in the plot). FSR is dependent on internal capacitor structure; substrate thickness and dielectric constant; capacitor orientation, as defined alongside the FPR plot; and mounting pad dimensions.

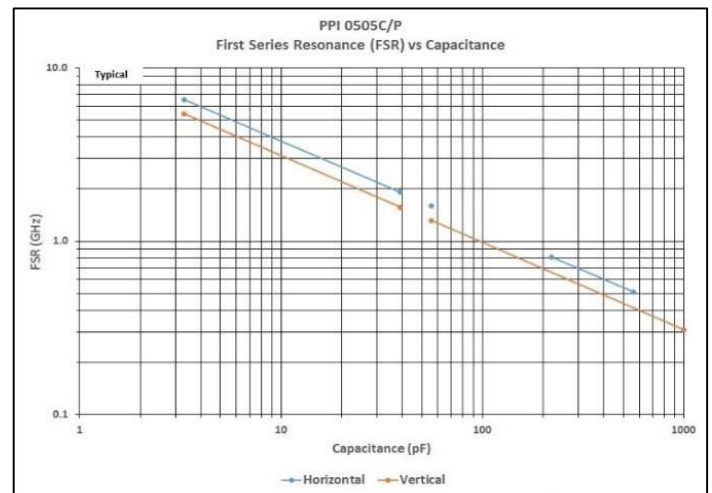

The measurement conditions are: substrate – Rogers RO4350; substrate dielectric constant = 3.66; horizontal mount substrate thickness (mils) = 25; gap in microstrip trace (mils) = 15; horizontal mount microstrip trace width (mils) = 55. Reference planes at sample edges.

All data has been derived from electrical models created by Modelithics, Inc., a specialty vendor contracted by PPI. The models are derived from measurements on a large number of parts disposed on several different substrates.



Traditional High Q (>10,000) Low ESR
Multi-Layer Ceramic Capacitors

0505C/P (0.055" x 0.055")

≠ ESR vs. Frequency

0505C/P ESR vs Frequency

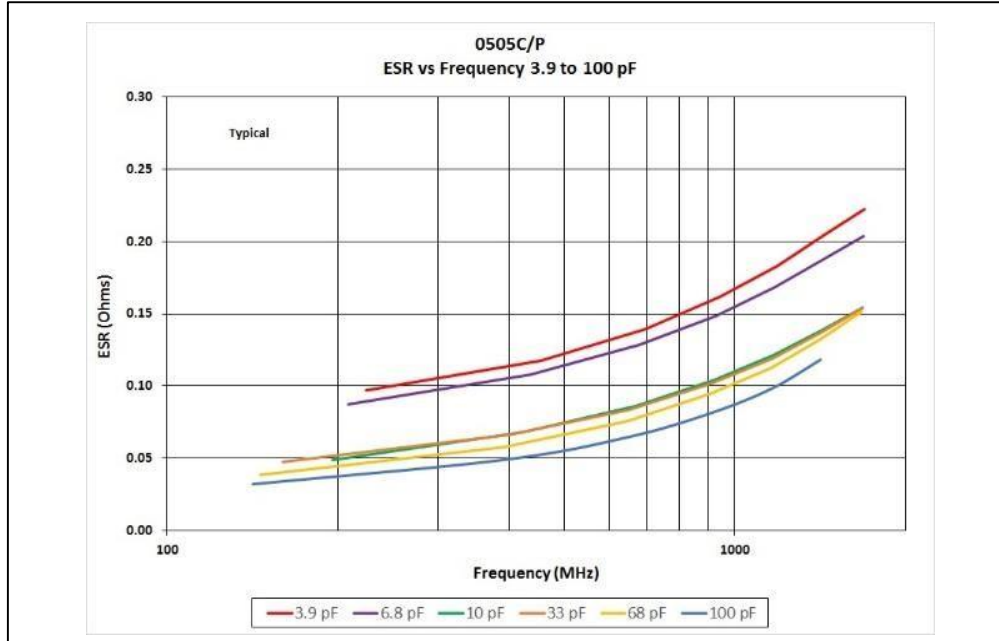

0505C ESR vs Frequency





Traditional High Q (>10,000) Low ESR
Multi-Layer Ceramic Capacitors

0505C/P (0.055" x 0.055")

≠ Q vs. Frequency

0505C/P Q vs Frequency



0505C Q vs Frequency



≠ Current Rating vs. Capacitance

0505C/P Current Rating vs Capacitance

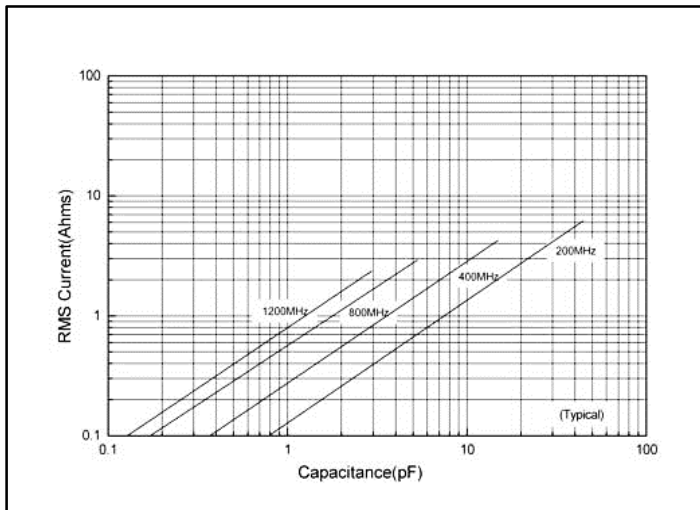

The current depends on voltage limited:

$$I = \frac{\sqrt{2}}{2} I_{peak} = \frac{\sqrt{2}}{2} \times \frac{V_{rated}}{X_c} = \sqrt{2} \pi f C V_{rated}$$

The current depends on power dissipation limited:

$$I = \sqrt{\frac{P_{dissipation}}{ESR}}$$

0505C Current Rating vs Capacitance

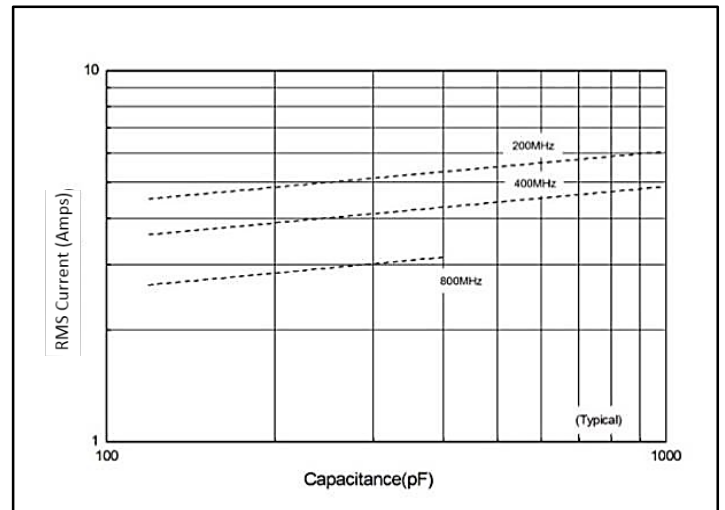

Note: If the thermal resistance of mounting surface is 40°C/W, then a power dissipation of 1.5 W will result in the current limited we can calculate the current limited:

$$I = \sqrt{\frac{P_{dissipation}}{ESR}}$$



Traditional High Q (>10,000) Low ESR
Multi-Layer Ceramic Capacitors

0505C/P (0.055" x 0.055")

≠ Capacitor Application Program

Passive Plus, Inc.'s brand new **online Capacitor Application Program (C.A.P.)** helps Engineers and Designers select capacitors according to parameters such as cap value and frequency. C.A.P. allows engineers to insert capacitor requirements (Cap value, Frequency), producing Scattering Matrices (S2P) Charts while providing options (Case Size, Terminations, Mounting), and parameters (ESR, Q, Impedance) along with Datasheets. Once engineers have determined their capacitor requirements, C.A.P. also includes online Requests For Quotes (RFQs) and/or sample requests.

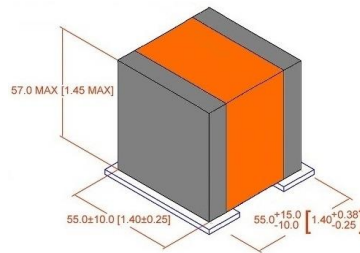

≠ Modelithics Vendor Program

PPI offers design engineers a Free 90-Day Trial license for the Modelithics PPI Component Library. This program provides engineers access to extremely accurate scalable simulation models for Passive Plus capacitors with advanced features that enable a more precise and rapid design process.

Microwave Global Models include every part value in a series and permit users to input substrate thickness, dielectric constant, and loss tangent, as well as mounting pad layout dimensions. Selected models also include capacitor orientation – vertical or horizontal – as an input. Engineers can request FREE use of the models, by either visiting the [Passive Plus Resources page \(http://passiveplus.com/addldocs_resources.php\)](http://passiveplus.com/addldocs_resources.php).



≡ Recommended Land Pattern Dimensions

When mounting the capacitor to substrate, it's important to carefully consider that the amount of solder (size of fillet) used has a direct effect upon the capacitor once it's mounted.

- 1) The greater the amount of solder, the greater the stress to the elements. This may cause the substrate to break or crack.
- 2) In the situation where two or more devices are mounted onto a common land, be sure to separate the device into exclusive pads by using soldering resist.

≡ Horizontal Mounting (mm)

A	B	C
0.5-0.7	0.7-0.9	1.2-1.4

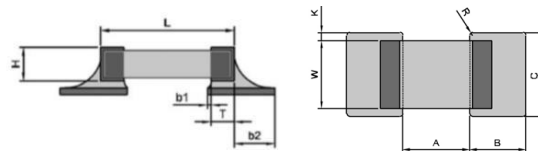

≡ Vertical Mounting* (mm)

A	B	C
0.5-0.7	0.7-0.9	1.0-1.2

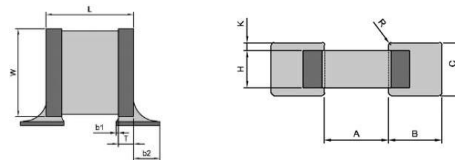

*Only available below 430pF

≡ Tape & Reel Specifications (mm)

Horizontal Orientation

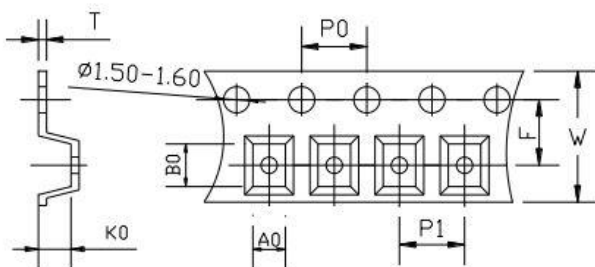

Vertical Orientation

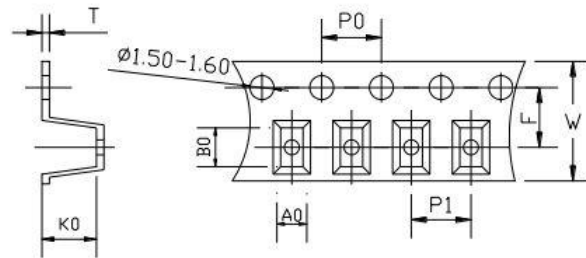

Orientation	W	P0	P1	T	F	Qty Min	Qty/reel	Tape Material
Horizontal	8.00	4.00	4.00	0.22	3.50	500	3000	Plastic
Vertical	12.00	4.00	4.00	0.30	5.50	300	2000	Plastic

A₀ B₀ K₀

- Determined by component size. Typical clearance between the cavity and the component is:
.05 (.002) min to .50 (.020) max for 8mm tape and .50 (.002) min to .65 (.026) max for 12mm tape.
- The component cannot rotate more than 20° within the determined cavity.



Traditional High Q (>10,000) Low ESR
Multi-Layer Ceramic Capacitors

0505C/P (0.055" x 0.055")

≠ Engineering Design Kits

PPI offers Design Kits for engineers who are building and testing prototypes. Each kit contains 16 values; 10 pieces per value.



Kits are offered in Magnetic or Non-Magnetic Terminations. Kits are 100% RoHS compliant.

Kit Number		Value Range	Values	
MAGNETIC	NON-MAGNETIC			
DKD0505C01	DKD0505C05	0.1 - 2.0pF	0.1, 0.2, 0.3, 0.4, 0.5, 0.6, 0.7, 0.8, 0.9, 1.0, 1.2, 1.5, 1.6, 1.8, 2.0pF	✓ RoHS
DKD0505P01	DKD0505P05			
DKD0505C02	DKD0505C06	1 - 10pF	1.0, 1.2, 1.5, 1.8, 2.0, 2.2, 2.4, 2.7, 3.0, 3.3, 3.9, 4.7, 5.6, 6.8, 8.2, 10pF	✓ RoHS
DKD0505P02	DKD0505P06			
DKD0505C03	DKD0505C07	10 - 100pF	10, 12, 15, 18, 20, 22, 24, 27, 30, 33, 39, 47, 56, 68, 82, 100pF	✓ RoHS
DKD0505P03	DKD0505P07			
DKD0505C04	DKD0505C08	100 - 1000pF	100, 120, 150, 180, 200, 220, 240, 270, 300, 330, 390, 470, 560, 680, 820, 1000pF	✓ RoHS

PPI
Passive Plus Inc.
RF & Microwave Components

DKD0505C01

0505C Series 0.1 — 2.0pF
Size: 0.055" x 0.055"
TC = NP0 WVDC = 150V

Hi-Q Low ESR Capacitor Design Kit

www.passiveplus.com

PPI
Passive Plus Inc.
RF & Microwave Components

DKD0505C02

0505C Series 1.0 — 10pF
Size: 0.055" x 0.055"
TC = NP0 WVDC = 150V

Hi-Q Low ESR Capacitor Design Kit

www.passiveplus.com

PPI
Passive Plus Inc.
RF & Microwave Components

DKD0505C03

0505C Series 10 — 100pF
Size: 0.055" x 0.055"
TC = NP0 WVDC = 150V

Hi-Q Low ESR Capacitor Design Kit

www.passiveplus.com

PPI
Passive Plus Inc.
RF & Microwave Components

DKD0505C04

0505C Series 100 — 1000pF
Size: 0.055" x 0.055"
TC = NP0 WVDC = 150V

Hi-Q Low ESR Capacitor Design Kit

www.nassivenlus.com

PPI
Passive Plus Inc.
RF & Microwave Components

DKD0505P01

0505P Series 0.1 — 2.0pF
Size: 0.055" x 0.055"
TC = P90 WVDC = 150V

Hi-Q Low ESR Capacitor Design Kit

www.passiveplus.com

PPI
Passive Plus Inc.
RF & Microwave Components

DKD0505P02

0505P Series 1.0 — 10pF
Size: 0.055" x 0.055"
TC = P90 WVDC = 150V

Hi-Q Low ESR Capacitor Design Kit

www.passiveplus.com

PPI
Passive Plus Inc.
RF & Microwave Components

DKD0505P03

0505P Series 10 — 100pF
Size: 0.055" x 0.055"
TC = P90 WVDC = 150V

Hi-Q Low ESR Capacitor Design Kit

www.passiveplus.com



Traditional High Q (>10,000) Low ESR
Multi-Layer Ceramic Capacitors

1111C/P (0.110" x 0.110")

≠ Product Features

- High Q
- High Power
- Low ESR/ESL
- Low Noise
- High Self-Resonance
- Ultra Stable Performance
- Capacitance Range:
0.1pF to 10000pF
- Working Voltage: 500V
- Extended Voltage: 1500V

≠ Product Applications

Typical Functional Applications

- Tuning • Bypass • Coupling
- Feedback • D.C. Blocking
- Impedance Matching

Typical Circuit Applications

- UHF/Microwave RF Power Amplifiers
- Mixers • Oscillators • Filter Networks
- Low Noise Amplifiers • Timing Circuits
and Delay Lines



Marking shown for illustration purposes only.
Actual marking may differ.

≠ Part Numbering

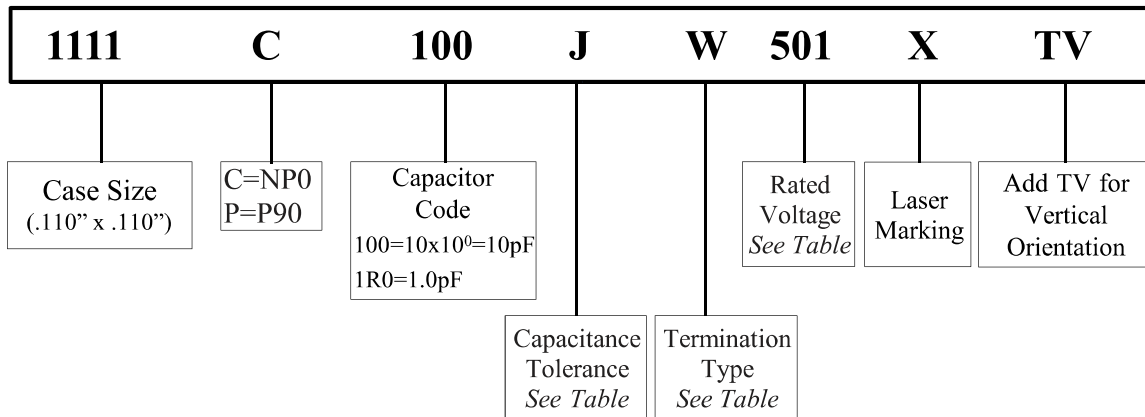

≠ Capacitance Tolerance Codes

Code	A	B	C	D	F	G	J	K
Tol.	±0.05pF	±0.1pF	±0.25pF	±0.5pF	±1%	±2%	±5%	±10%

≠ Voltage Codes

Voltage	Code
50V	500
100V	101
200V	201
300V	301
500V	501
600V	601
1000V	102
1500V	152



Traditional High Q (>10,000) Low ESR
Multi-Layer Ceramic Capacitors

1111C/P (0.110" x 0.110")

≠ 1111C/P Capacitance Values

- NP0=C; P90=P
- **Maximum Capacitance: 1111P=1000pF; 1111C=10000pF**
- * - Available in NP0 only.

Special capacitances, tolerances and WVDC are available. Please contact PPI.



Marking shown for illustration purposes only.
Actual marking may differ.

Cap. pF	Cap Code	Tol.	Rated WVDC		Cap. pF	Cap Code	Tol.	Rated WVDC		Cap. pF	Cap Code	Tol.	Rated WVDC		Cap. pF	Cap Code	Tol.	Rated WVDC	
			Std.	Ext.				Std.	Ext.				Std.	Ext.				Std.	Ext.
0.1	OR1	A,B	500V	1000V or 1500V	3.3	3R3	A,B C,D	500V	1000V or 1500V	36	360	F,G, J,K	500V	1000V or 1500V	390	391	F,G, J,K	200V	600V
0.2	OR2				3.6	3R6				39	390				430	431			
0.3	OR3				3.9	3R9				43	430				470	471			
0.4	OR4				4.3	4R3				47	470				510	511			
0.5	OR5	A,B, C,D	500V	1000V or 1500V	4.7	4R7	F,G, J,K	500V	1000V or 1500V	51	510	F,G, J,K	300V	1000V	560	561	F,G, J,K	100V	200V
0.6	OR6				5.1	5R1				56	560				620	621			
0.7	OR7				5.6	5R6				62	620				680	681			
0.8	OR8				6.2	6R2				68	680				750	751			
0.9	OR9				6.8	6R8				75	750				820	821			
1.0	1R0				7.5	7R5				82	820				910	911			
1.1	1R1				8.2	8R2				91	910				1000	102			
1.2	1R2				9.1	9R1				100	101				1100	112*			
1.3	1R3				10	100				110	111				1200	122*			
1.4	1R4				11	110				120	121				1500	152*			
1.5	1R5	12	120	130	131	1800	182*												
1.6	1R6	F,G, J,K	500V	1000V or 1500V	13	130	F,G, J,K	300V	1000V	2200	222*	F,G, J,K	100V	N/A					
1.7	1R7				15	150				160	161				2700	272*			
1.8	1R8				16	160				180	181				3000	302*			
1.9	1R9				18	180				200	201				3300	332*			
2.0	2R0				20	200				220	221				4700	472*			
2.1	2R1				22	220				240	241				5100	512*			
2.2	2R2				24	240				270	271				5600	562*			
2.4	2R4				27	270				300	301				10000	103*			
2.7	2R7				30	300				330	331								
3.0	3R0				33	330				360	361								

*Available in NP0 only



Traditional High Q (>10,000) Low ESR
Multi-Layer Ceramic Capacitors

1111C/P (0.110" x 0.110")

≠ Terminations Types and Codes

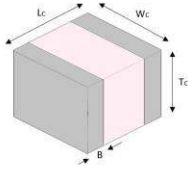

Chip Termination:
Codes: **W, L, P**

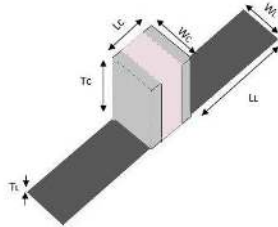

Microstrip Termination:
Codes: **MS, MN**

Magnetic Terminations

Termination Code	Termination
W	100% Sn Solder over Nickel Plating
L	90% Sn10%Pb Tin/Lead Solder over Nickel Plating
MS	100% Silver

⊗ Non-Magnetic Terminations ⊗

P	100%Sn Solder over Copper Plating
MN	100% Silver

≠ Capacitor Dimensions Unit: inch (millimeter)

Magnetic Terminations								
Code	Term.	Capacitor Dimensions				Lead Dimensions		
		Length	Width	Thickness	Overlap	Length	Width	Thickness
		Lc	Wc	Tc	B	LL	WL	TL

W/L	Chip	0.110 + 0.020 to -0.010 (2.79 +0.51 to -0.25)	0.110 ± 0.010 (2.79 ±0.25)	0.10 (2.54 max)	0.024 (0.60max)	-	-	-
-----	------	---	-------------------------------	--------------------	--------------------	---	---	---

MS	Microstrip	0.135 ± 0.015 (3.43 ± 0.38)	0.110 ± 0.010 (2.79 ±0.25)	0.10 (2.54 max)	-	0.250 (6.35) min	0.093 ±0.005 (2.36 ± 0.13)	0.004 ± 0.001 (0.10 ± 0.13)
----	------------	--------------------------------	-------------------------------	--------------------	---	---------------------	-------------------------------	--------------------------------

⊗ Non-Magnetic Terminations ⊗

Code	Term.	Length	Width	Thickness	Overlap	Length	Width	Thickness
		Lc	Wc	Tc	B	LL	WL	TL

P	Chip	0.110 + 0.020 to -0.010 (2.79 +0.51 to -0.25)	0.110 ± 0.010 (2.79 ±0.25)	0.10 (2.54 max)	0.024 (0.60max)	-	-	-
---	------	---	-------------------------------	--------------------	--------------------	---	---	---

MN	Microstrip Non-Magnetic	0.135 ± 0.015 (3.43 ± 0.38)	0.110 ± 0.010 (2.79 ±0.25)	0.10 (2.54 max)	-	0.250 (6.35) min	0.093 ±0.005 (2.36 ± 0.13)	0.004 ± 0.001 (0.10 ± 0.13)
----	----------------------------	--------------------------------	-------------------------------	--------------------	---	---------------------	-------------------------------	--------------------------------

Note: "Non-Magnetic" means no magnetic materials.



Traditional High Q (>10,000) Low ESR
Multi-Layer Ceramic Capacitors

1111C/P (0.110" x 0.110")

⚡ Electrical Specifications

Quality Factor (Q)	Greater than 10,000 at 1 MHz
Insulation Resistance (IR)	0.1pF to 470pF: 10 ⁶ Megaohms min. @ +25°C rated WVDC
	10 ⁵ Megaohms min. @ +125°C rated WVDC
	510pF to 1000pF: 10 ⁵ Megaohms min. @ +25°C rated WVDC 10 ⁴ Megaohms min. @ +125°C rated WVDC
Rated Voltage	See Rated Voltage Table
Dielectric Withstanding Voltage (WVDC)	250% of Rated Voltage of 5 seconds, Rated Voltage ≤ 500VDC
	150% of Voltage for 5 seconds, 500VDC < Rated Voltage ≤ 1250 VDC
	120% of Voltage for 5 seconds, Rated Voltage > 1250 VDC
Operating Temperature Range	-55°C to 200°C
Temperature Coefficient (TC)	C: -55°C to 125°C 0±30ppm/°C;
	>125°C to 200°C 0±60ppm/°C
	P: +90±20ppm/°C
Capacitance Drift	±0.02% or ±0.02pF, whichever is greater
Piezoelectric Effects	None
Termination Type	See Termination Type Table

⚡ Environmental Specifications

Specification	Test Parameters
Thermal Shock DWV: The initial Value IR: Shall not be less than 30% of the initial value. Capacitance Change:	MIL-STD-202, Method 107, Condition A. At the maximum rated temperature (-55°C and 200°C) stay 30 minutes, the time of removing shall not be more than 3 minutes. Perform five cycles.
Moisture Resistance No more than 0.5% or 0.5pF, whichever is greater.	MIL-STD-202, Method 106
Humidity (Steady State) DWV: The initial Value IR: The initial value. Capacitance Change:	MIL-STD-202, Method 103, Condition A With 1.5Volts DC applied while subjected to an environment of 85°C with 85% relative humidity for 240 hours minimum.
Life IR: Shall not be less than 30% of the initial value. Capacitance Change: No more than 2.0% or 0.5pF, whichever is greater.	MIL-STD-202, Method 108. For 2000 hours, at 200°C. 200% of Voltage for Capacitors, Rated Voltage ≤ 500VDC; 120% of Voltage for Capacitors, 500VDC < Rated Voltage ≤ 1250VDC; 100% for Voltage for Capacitors, Rated Voltage > 1250VDC
Terminal Strength Force: 10lbs typical, 5lbs. Minimum. Duration Time: 5 to 10 seconds	MIL-STD-202, Method 211A, Test Condition A. Applied a force and maintained for a period of 5 to 10 seconds. The force shall be in the direction of the axes of the terminations.

Capacitors are designed and manufactured to meet the requirements of MIL-PRF-55681 and MIL-PRF-123.



≠ FPR -- First Parallel Resonance (FPRs)

≠ Definitions and Measurement Conditions

The **First Parallel Resonance, FPR**, is defined as the lowest frequency at which a suckout or notch appears in $|S_{21}|$.

It is generally independent of substrate thickness or dielectric constant, but does depend on capacitor orientation. A horizontal orientation means the capacitor electrode planes are parallel to the plane of the substrate; a vertical orientation means the electrode planes are perpendicular to the substrate.

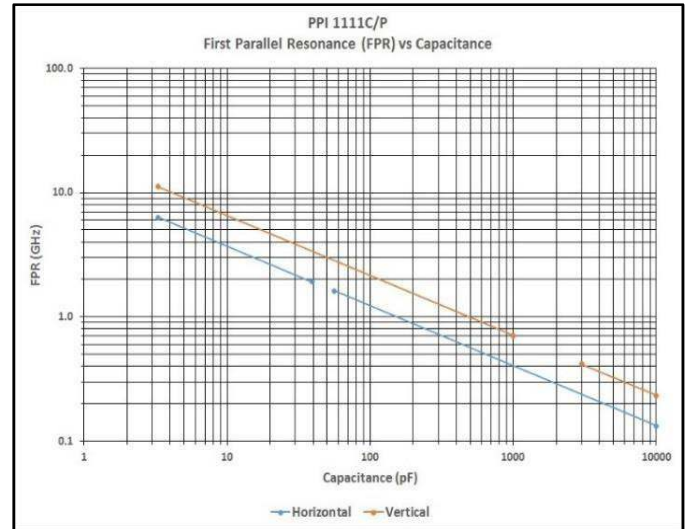

≠ FSR -- First Series Resonance (FSRs)

≠ Definitions and Measurement Conditions

The **First Series Resonance, FSR**, is defined as the lowest frequency at which the imaginary part of the input impedance, $\text{Im}[Z_{in}]$, equals zero. Should $\text{Im}[Z_{in}]$ or the real part of the input impedance, $\text{Re}[Z_{in}]$, not be monotonic with frequency at frequencies lower than those at which $\text{Im}[Z_{in}] = 0$, the FSR shall be considered as undefined (represented as a gap in the plot). FSR is dependent on internal capacitor structure; substrate thickness and dielectric constant; capacitor orientation, as defined alongside the FPR plot; and mounting pad dimensions.



The measurement conditions are: substrate – Rogers RO4350; substrate dielectric constant = 3.66; horizontal mount substrate thickness (mils) = 50; gap in microstrip trace (mils) = 72; horizontal mount microstrip trace width (mils) = 110. Reference planes at sample edges.

All data has been derived from electrical models created by Modelithics, Inc., a specialty vendor contracted by PPI. The models are derived from measurements on a large number of parts disposed on several different substrates.



Traditional High Q (>10,000) Low ESR
Multi-Layer Ceramic Capacitors

1111C/P (0.110" x 0.110")

≠ ESR vs. Frequency

1111C/P ESR vs Frequency



1111C ESR vs Frequency





Traditional High Q (>10,000) Low ESR
Multi-Layer Ceramic Capacitors

1111C/P (0.110" x 0.110")

≠ Q vs. Capacitance

1111C/P Q vs Frequency



1111C Q vs Frequency

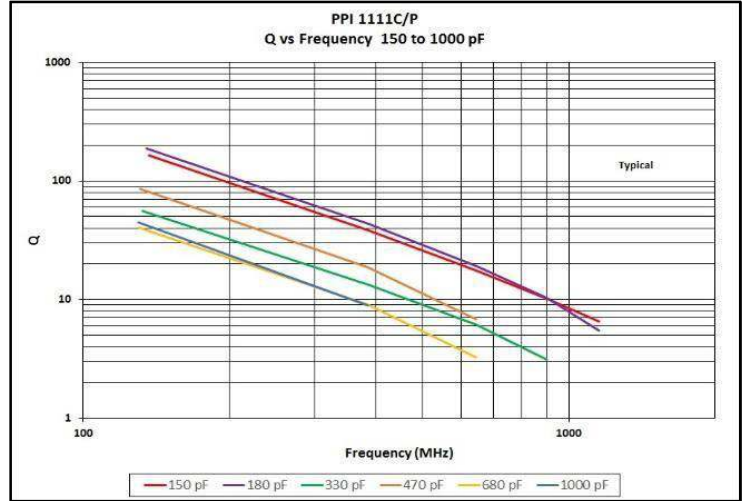

≠ Current Rating vs. Capacitance

1111C/P Current Rating vs Capacitance

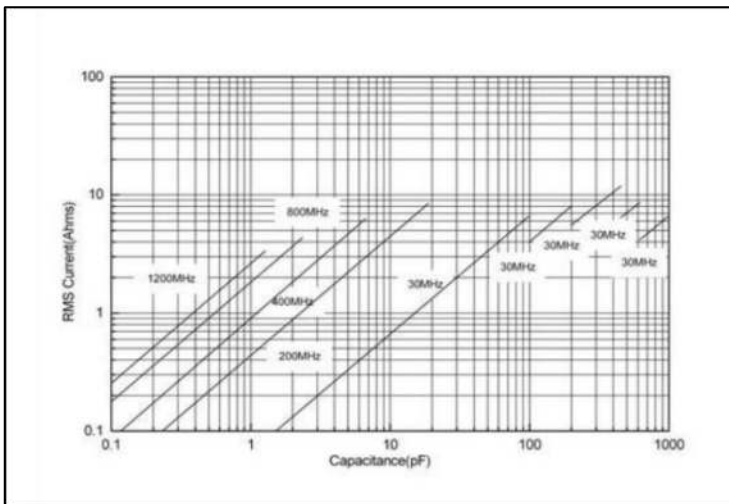

1111C Current Rating vs Capacitance

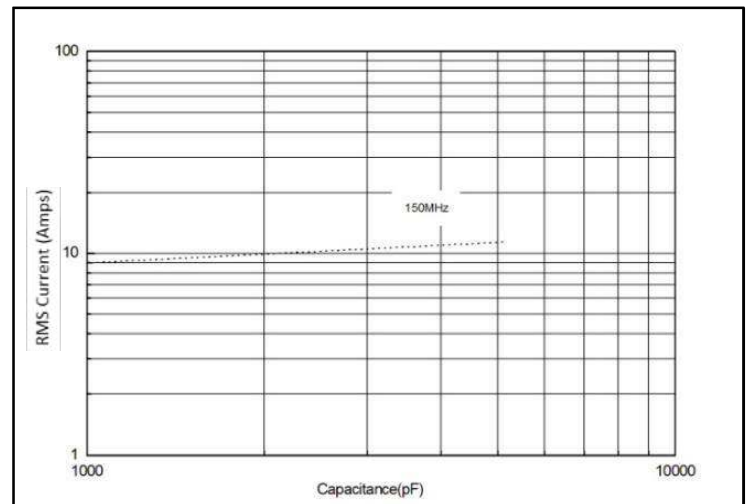

The current depends on voltage limited:

$$I = \frac{\sqrt{2}}{2} I_{peak} = \frac{\sqrt{2}}{2} \times \frac{V_{rated}}{X_c} = \sqrt{2} \pi f C V_{rated}$$

The current depends on power dissipation limited:

$$I = \sqrt{\frac{P_{dissipation}}{ESR}}$$

Note: If the thermal resistance of mounting surface is 20°C/W, then a power dissipation of 3 W will result in the current limited we can calculate the current limited:

$$I = \sqrt{\frac{P_{dissipation}}{ESR}}$$



Traditional High Q (>10,000) Low ESR
Multi-Layer Ceramic Capacitors

1111C/P (0.110" x 0.110")

≠ Capacitor Application Program

Passive Plus, Inc.'s brand new **online Capacitor Application Program (C.A.P.)** helps Engineers and Designers select capacitors according to parameters such as cap value and frequency. C.A.P. allows engineers to insert capacitors requirements (Cap value, Frequency), producing Scattering Matrices (S2P) Charts while providing options (Case Size, Terminations, Mounting), and parameters (ESR, Q, Impedance) along with Datasheets. Once engineers have determined their capacitor requirements, C.A.P. also includes online Requests For Quotes (RFQs) and/or sample requests.

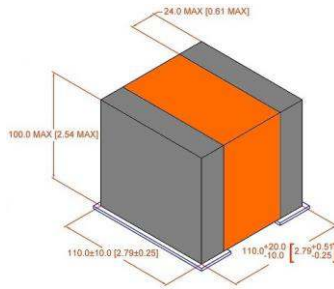

≠ Modelithics Vendor Program

PPI offers design engineers a Free 90-Day Trial license for the Modelithics PPI Component Library. This program provides engineers access to extremely accurate scalable simulation models for Passive Plus capacitors with advanced features that enable a more precise and rapid design process.

Microwave Global Models include every part value in a series and permit users to input substrate thickness, dielectric constant, and loss tangent, as well as mounting pad layout dimensions. Selected models also include capacitor orientation – vertical or horizontal – as an input. Engineers can request FREE use of the models, by either visiting the [Passive Plus Resources page](http://passiveplus.com/addldocs_resources.php) (http://passiveplus.com/addldocs_resources.php).



≠ Recommended Land Pattern Dimensions

When mounting the capacitor to substrate, it's important to carefully consider that the amount of solder (size of fillet) used has a direct effect upon the capacitor once it's mounted.

- 1) The greater the amount of solder, the greater the stress to the elements. This may cause the substrate to break or crack.
- 2) In the situation where two or more devices are mounted onto a common land, be sure to separate the device into exclusive pads by using soldering resist.

≠ Horizontal Mounting (mm)

A	B	C
1.9	1.7	2.9

≠ Vertical Mounting (mm)

A	B	C
1.9	1.7	2.5

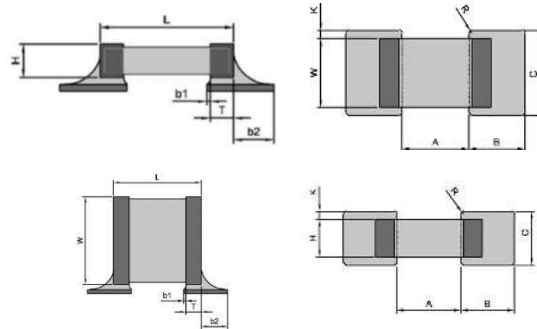

≠ Tape & Reel Specifications (mm)

Horizontal Orientation

Vertical Orientation

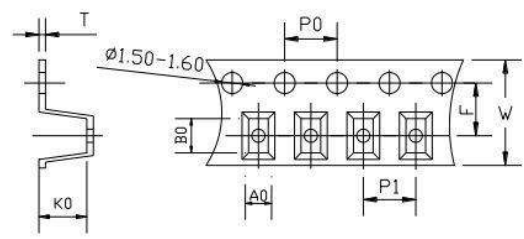
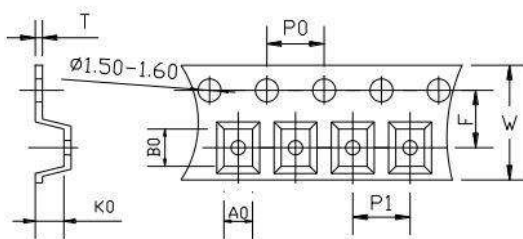

Orientation	W	P0	P1	T	F	Qty Min	Qty/reel	Tape Material
Horizontal	8.00	4.00	4.00	0.22	3.50	500	2000	Plastic
Vertical	12.00	4.00	4.00	0.40	5.50	500	1500	Plastic
Vertical	8.00	4.00	4.00	0.22	3.50	500	1500	Plastic

A₀ B₀ K₀

- Determined by component size. Typical clearance between the cavity and the component is:
.05 (.002) min to .50 (.020) max for 8mm tape and .50 (.002) min to .65 (.026) max for 12mm tape.
- The component cannot rotate more than 20° within the determined cavity.

Dimensions: mm



Traditional High Q (>10,000) Low ESR
Multi-Layer Ceramic Capacitors

1111C/P (0.110" x 0.110")

Engineering Design Kits

PPI offers Design Kits for engineers who are building and testing prototypes. Each kit contains 16 values; 10 pieces per value.



Kits are offered in Magnetic or Non-Magnetic Terminations. Kits are 100% RoHS compliant.

Kit Number		Value Range	Values	
MAGNETIC	NON-MAGNETIC			
DKD1111C01 DKD1111P01	DKD1111C05 DKD1111P05	1.0 - 10pF	1.0, 1.2, 1.5, 1.8, 2.0, 2.2, 2.4, 2.7, 3.0, 3.3, 3.9, 4.7, 5.6, 6.8, 8.2, 10pF	✓ RoHS
DKD1111C02 DKD1111P02	DKD1111C06 DKD1111P06	10 - 100pF	10, 12, 15, 18, 20, 22, 24, 27, 30, 33, 39, 47, 56, 68, 82, 100pF	✓ RoHS
DKD1111C03 DKD1111P03	DKD1111C07 DKD1111P07	100 - 1000pF	100, 120, 150, 180, 200, 220, 240, 270, 300, 330, 390, 470, 560, 680, 820, 1000pF	✓ RoHS
DKD1111C04 DKD1111P04	DKD1111C08 DKD1111P08	1000 - 10000pF	1000, 1100, 1200, 1500, 1800, 2000, 2200, 2700, 3000, 3300, 3900, 4700, 5100, 5600, 10000pF	✓ RoHS

PPI
Passive Plus Inc.
RF & Microwave Components

DKD1111C01

1111C Series 1.0 — 10pF
Size: 0.110" x 0.110"
TC = NP0 WVDC = 500V

Hi-Q Low ESR Capacitor Design Kit

PPI
Passive Plus Inc.
RF & Microwave Components

DKD1111C02

1111C Series 10 — 100pF
Size: 0.110" x 0.110"
TC = NP0 WVDC = 500V

Hi-Q Low ESR Capacitor Design Kit

PPI
Passive Plus Inc.
RF & Microwave Components

DKD1111C03

1111C Series 100 — 1000pF
Size: 0.110" x 0.110"
TC = NP0 WVDC = 500V

Hi-Q Low ESR Capacitor Design Kit

PPI
Passive Plus Inc.
RF & Microwave Components

DKD1111C04

1111C Series 1000 — 10000pF
Size: 0.110" x 0.110"
TC = NP0 WVDC = 100V

Hi-Q Low ESR Capacitor Design Kit

PPI
Passive Plus Inc.
RF & Microwave Components

DKD1111P01

1111P Series 1.0 — 10pF
Size: 0.110" x 0.110"
TC = P90 WVDC = 500V

Hi-Q Low ESR Capacitor Design Kit

www.passiveplus.com

PPI
Passive Plus Inc.
RF & Microwave Components

DKD1111P02

1111P Series 10 — 100pF
Size: 0.110" x 0.110"
TC = P90 WVDC = 500V

Hi-Q Low ESR Capacitor Design Kit

www.passiveplus.com

PPI
Passive Plus Inc.
RF & Microwave Components

DKD1111P03

1111P Series 100 — 1000pF
Size: 0.110" x 0.110"
TC = P90 WVDC = 500V

Hi-Q Low ESR Capacitor Design Kit

www.passiveplus.com

PPI
Passive Plus Inc.
RF & Microwave Components

DKD1111P04

1111P Series 1000 — 10000pF
Size: 0.110" x 0.110"
TC = P90 WVDC = 100V

Hi-Q Low ESR Capacitor Design Kit

www.passiveplus.com



Traditional High Q (>10,000) Low ESR
Multi-Layer Ceramic Capacitors

2225C/P (0.220" x 0.250")

≠ Product Features

- High Q
- High RF Current/Voltage
- Ultra Stable Performance
- Capacitance Range:
0.5pF to 2700pF
- Working Voltage: 2500V
- Extended Voltage: 3600V

≠ Product Applications

Typical Functional Applications:

- Tuning • Bypass • Coupling
- D.C. Blocking • Impedance Matching

Typical Circuit Applications

- UHF/Microwave RF Power Amplifiers
- Antenna Tuning • Plasma Chambers
- Medical Equipment



Marking shown for illustration purposes only.
Actual marking may differ.

≠ Part Numbering

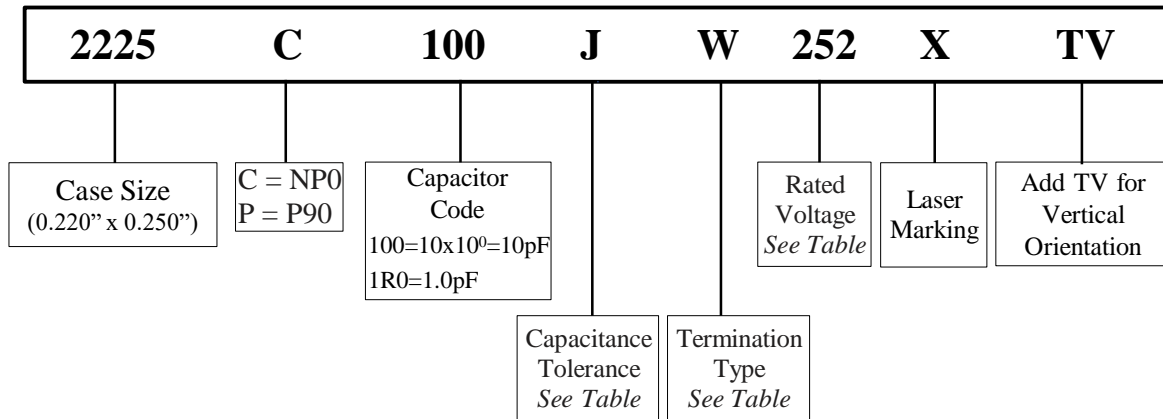

≠ Capacitance Tolerance Codes

Code	A	B	C	D	F	G	J	K
Tol.	±0.05pF	±0.1pF	±0.25pF	±0.5pF	±1%	±2%	±5%	±10%

≠ Voltage Codes

Voltage	Code
500V	501
1000V	102
1500V	152
2000V	202
2500V	252
3000V	302
3600V	362



Traditional High Q (>10,000) Low ESR
Multi-Layer Ceramic Capacitors

2225C/P (0.220" x 0.250")

≠ 2225C/P Capacitance Values

- NP0=C; P90=P

Special capacitances, tolerances and WVDC are available. Please contact PPI.

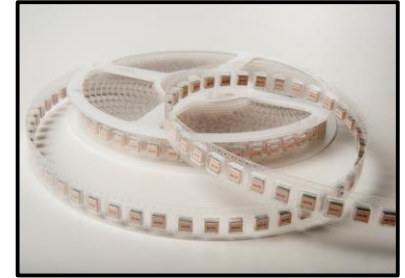

Cap. pF	Cap Code	Tol.	Rated WVDC		Cap. pF	Cap Code	Tol.	Rated WVDC		Cap. pF	Cap Code	Tol.	Rated WVDC		Cap. pF	Cap Code	Tol.	Rated WVDC	
			Std.	Ext.				Std.	Ext.				Std.	Ext.				Std.	Ext.
0.5	0R5				4.3	4R3				43	430				430	431	F,G, J,K	1500V	2000V
0.6	0R6				4.7	4R7				47	470				470	471			
0.7	0R7				5.1	5R1				51	510				510	511			
0.8	0R8				5.6	5R6				56	560				560	561			
0.9	0R9				6.2	6R2	B,C, D	2500V	3600V	62	620	F,G, J,K	2500V	3600V	620	621			
1.0	1R0				6.8	6R8				68	680				680	681			
1.1	1R1				7.5	7R5				75	750				750	751	F,G, J,K	1000V	1500V
1.2	1R2				8.2	8R2				82	820				820	821			
1.3	1R3				9.1	9R1				91	910				910	911			
1.4	1R4				10	100				100	101				1000	102			
1.5	1R5				11	110				110	111				1100	112			
1.6	1R6	B,C, D	2500V	3600V	12	120				120	121				1200	122			
1.7	1R7				13	130				130	131				1500	152			
1.8	1R8				15	150				150	151				1800	182	F,G, J,K	500V	N/A
1.9	1R9				16	160				160	161	F,G, J,K	2500V	3000V	2200	222			
2.0	2R0				18	180				180	181				2700	272			
2.1	2R1				20	200	F,G, J,K	2500V	3600V	200	201								
2.2	2R2				22	220				220	221								
2.4	2R4				24	240				240	241								
2.7	2R7				27	270				270	271								
3.0	3R0				30	300				300	301								
3.3	3R3				33	330				330	331	F,G, J,K	1500V	2000V					
3.6	3R6				36	360				360	361								
3.9	3R9				39	390				390	391								



Traditional High Q (>10,000) Low ESR
Multi-Layer Ceramic Capacitors

2225C/P (0.220" x 0.250")

≠ Termination Types and Codes

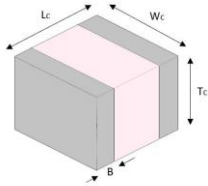

Chip Termination:
Codes: W, L, P

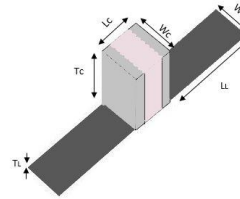

Microstrip Termination:
Codes: MS, MN

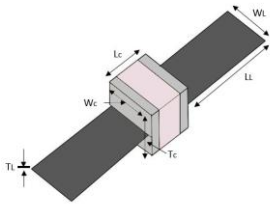

Axial Ribbon Termination:
Code: AR, AN

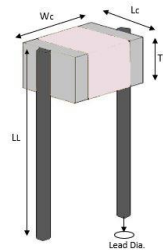

Radial Wire Termination:
Codes: RW, RN

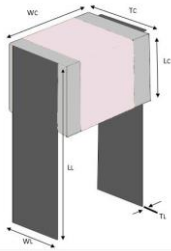

Radial Ribbon Termination:
Code: RR, FN

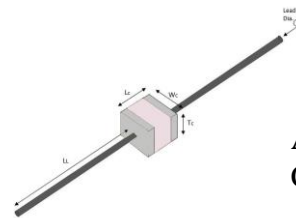

Axial Wire Termination:
Codes: AW, BN

Termination Code	Magnetic Termination	Termination Code	Non-Magnetic Termination
W	100% Sn Solder over Nickel Plating	P	100%Sn Solder over Copper Plating
L	90% Sn10%Pb Tin/Lead Solder over Nickel Plating	MN	
MS		AN	
AR		FN	Silver-Plated Copper
RR	Silver-Plated Copper	RN	
RW		BN	
AW			

Note: "Non-Magnetic" means no magnetic materials.



≠ Termination Types For Termination Types images, see previous page

Unit: inch (millimeter)

Magnetic Terminations								
Capacitor Dimensions					Lead Dimensions			
Code	Term.	Length Lc	Width Wc	Thickness Tc	Overlap B	Length LL	Width WL	Thickness TL
W/L	Chip	0.225 -0.010+0.25 (5.72 -0.25+ 0.64)	0.250 ± 0.015 (6.35 ± 0.38)	0.165 (4.19) max	0.020~0.047 (0.50~1.20) max	---	---	---
MS	Microstrip					0.500 (12.70) min	0.240 ±0.005 (6.1 ± 0.13)	0.008 ±0.001 (0.2 ±0.025)
AR	Axial Ribbon							
RR	Radial Ribbon	0.245 ± 0.025 (6.22 ± 0.64)	0.250 ±0.015 (6.35 ± 0.38)	0.150 (3.81) max		0.354 (9.00) min	0.118 ±0.005 (3.0 ±0.13)	0.012 ±0.001 (0.3 ±0.025)
RW	Radio Wire					0.709 (18.00) min	Dia. = 0.031 ±0.004 (0.80 ±0.10)	
AW	Axial Wire					0.906 (23.00) min		
⊗ Non-Magnetic Terminations ⊗								
Capacitor Dimensions					Lead Dimensions			
Code	Term.	Length Lc	Width Wc	Thickness Tc	Overlap B	Length LL	Width WL	Thickness TL
P	Chip	0.225 -0.010+0.25 (5.72 -0.25+ 0.64)	0.250 ± 0.015 (6.35 ± 0.38)	0.165 (4.19) max	0.020~0.047 (0.50~1.20) max			
MN	Microstrip					0.500 (12.70) min	0.240 ±0.005 (6.1 ± 0.13)	0.008 ±0.001 (0.2 ±0.025)
AN	Axial Ribbon							
FN	Radial Ribbon	0.245 ± 0.025 (6.22 ± 0.64)	0.250 ±0.015 (6.35 ± 0.38)	0.150 (3.81) max		0.354 (9.00) min	0.118 ±0.005 (3.0 ±0.13)	0.012 ±0.001 (0.3 ±0.025)
RN	Radial Wire					0.709 (18.00) min	Dia. = 0.031 ±0.004 (0.80 ±0.10)	
BN	Axial Wire					0.906 (23.00) min		

Note: Non-Magnetic means no magnetic materials. All leads are attached with high temperature solder and parts are RoHS Compliant.



⚡ Electrical Specifications

Quality Factor (Q)	Greater than 10,000 at 1 MHz
Insulation Resistance (IR)	Test Voltage: 500V 10 ⁵ Megaohms min. @ +25°C rated WVDC 10 ⁴ Megaohms min. @ +125°C rated WVDC
Rated Voltage	See Rated Voltage Table
Dielectric Withstanding Voltage (WVDC)	250% of Rated Voltage of 5 seconds, Rated Voltage ≤ 500VDC 150% of Voltage for 5 seconds, 500VDC < Rated Voltage ≤ 1250 VDC 120% of Voltage for 5 seconds, Rated Voltage > 1250 VDC
Operating Temperature Range	-55°C to 200°C
Temperature Coefficient (TC)	C: -55°C to 125°C 0±30ppm/°C; >125°C to 200°C 0±60ppm/°C P: -55°C to 200°C +90±20ppm/°C
Capacitance Drift	±0.02% or ±0.02pF, whichever is greater
Piezoelectric Effects	None
Termination Type	See Termination Type Table

Capacitors are designed and manufactured to meet the requirements of MIL-PRF-55681 and MIL-PRF-123.

⚡ Environmental Specifications

	Specification	Test Parameters
Thermal Shock	DWV: The initial Value IR: Shall not be less than 30% of the initial value. Capacitance Change:	MIL-STD-202, Method 107, Condition A. At the maximum rated temperature (-55°C and 200°C) stay 30 minutes, the time of removing shall not be more than 3 minutes. Perform five cycles.
Moisture Resistance	No more than 0.5% or 0.5pF, whichever is greater.	MIL-STD-202, Method 106
Humidity (Steady State)	DWV: The initial Value IR: The initial value. Capacitance Change: No more than 0.3% or 0.3pF, whichever is greater.	MIL-STD-202, Method 103, Condition A With 1.5Volts DC applied while subjected to an environment of 85°C with 85% relative humidity for 240 hours minimum.
Life	IR: Shall not be less than 30% of the initial value. Capacitance Change: No more than 2.0% or 0.5pF, whichever is greater.	MIL-STD-202, Method 108. For 2000 hours, at 200°C. 200% of Voltage for Capacitors, Rated Voltage ≤ 500VDC; 120% of Voltage for Capacitors, 500VDC < Rated Voltage ≤ 1250VDC; 100% for Voltage for Capacitors, Rated Voltage > 1250VDC
Terminal Strength	Force: 20lbs typical, 10lbs. Minimum. Duration Time: 5 to 10 seconds	MIL-STD-202, Method 211A, Test Condition A. Applied a force and maintained for a period of 5 to 10 seconds. The force shall be in the direction of the axes of the terminations.



Traditional High Q (>10,000) Low ESR
Multi-Layer Ceramic Capacitors

2225C/P (0.220" x 0.250")

≠ Series Resonance vs. Capacitance

Series Resonance vs. Capacitance

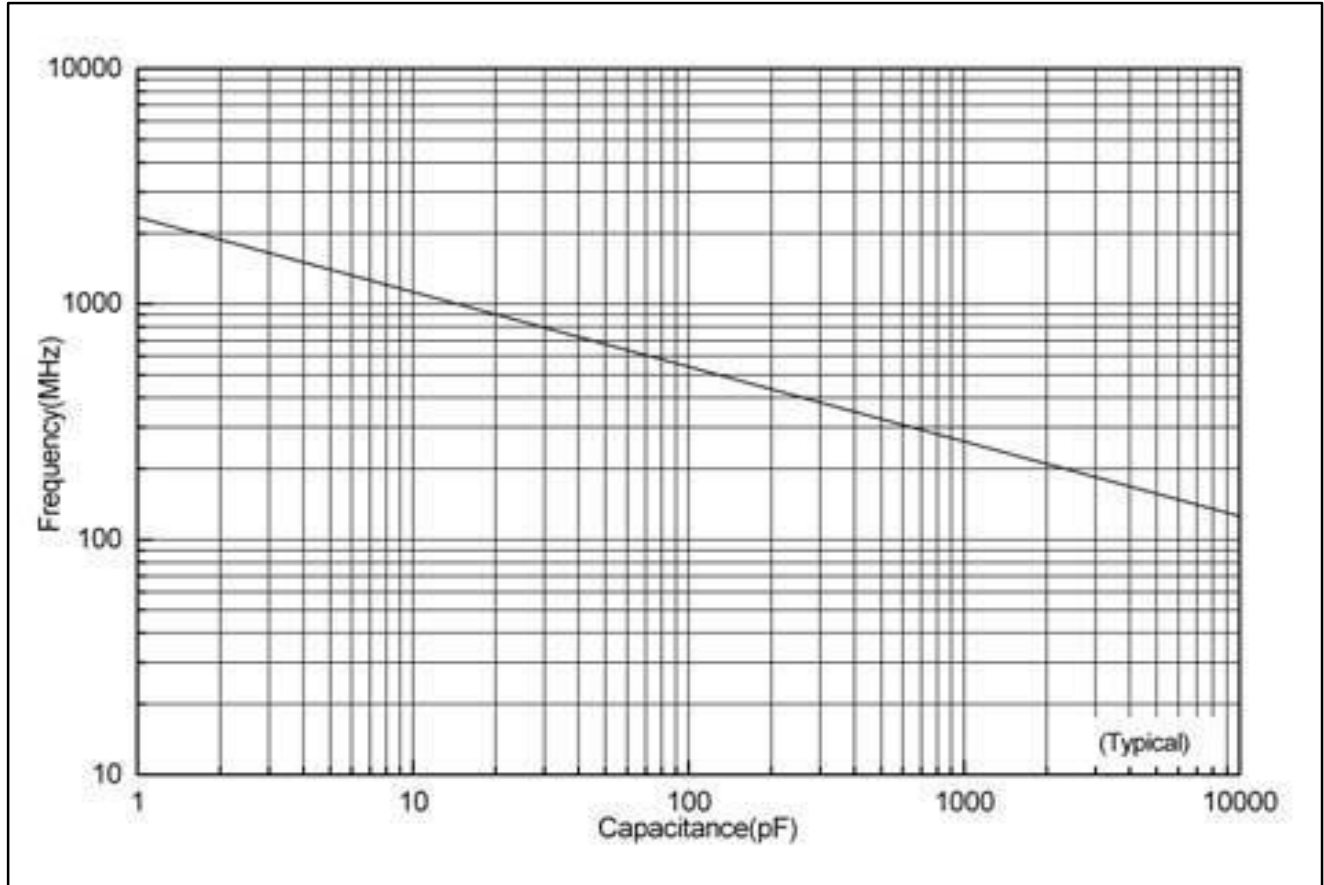



Traditional High Q (>10,000) Low ESR
Multi-Layer Ceramic Capacitors

2225C/P (0.220" x 0.250")

≠ ESR vs. Frequency

2225C/P ESR vs Frequency

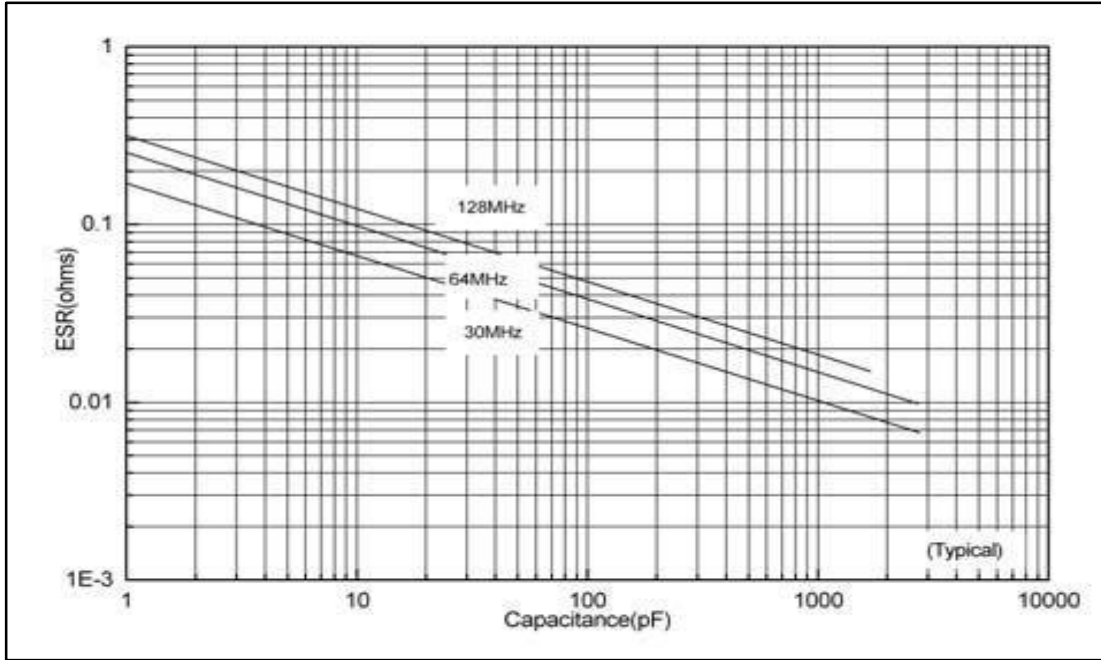

≠ Q vs. Capacitance

Q vs Capacitance

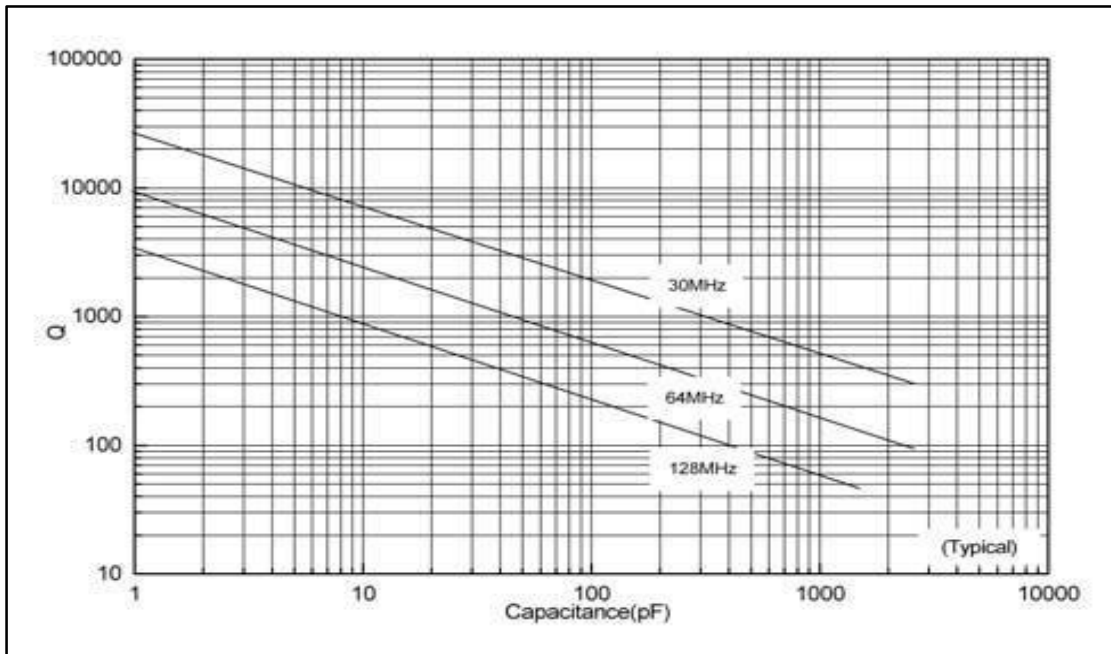

≠ Current Rating vs. Capacitance

2225C/P Current Rating vs Capacitance

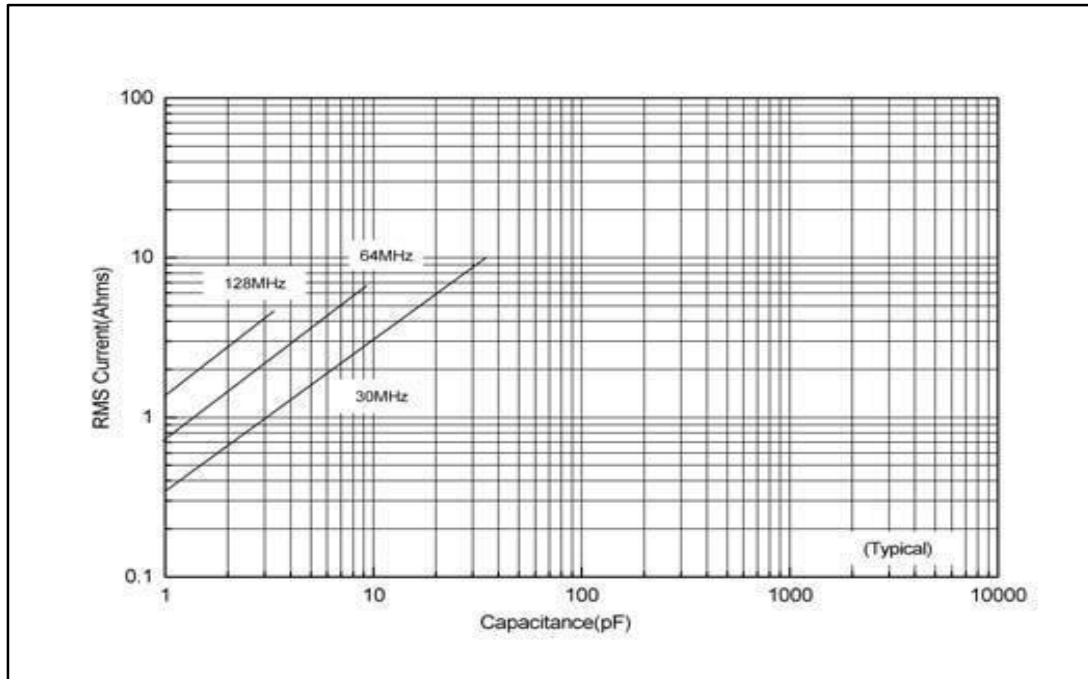

The current depends on voltage limited:
$$I = \frac{\sqrt{2}}{2} I_{peak} = \frac{\sqrt{2}}{2} \times \frac{V_{rated}}{X_c} = \sqrt{2\pi f C} V_{rated}$$

The current depends on power dissipation limited:
$$I = \sqrt{\frac{P_{dissipation}}{ESR}}$$

Note: If the thermal resistance of mounting surface is 15°C/W, then a power dissipation of 4W will result in the current limited.

We can calculate the current limited.



Traditional High Q (>10,000) Low ESR
Multi-Layer Ceramic Capacitors

2225C/P (0.220" x 0.250")

≠ Capacitor Application Program

Passive Plus, Inc.'s brand new **online Capacitor Application Program (C.A.P.)** helps Engineers and Designers select capacitors according to parameters such as cap value and frequency. C.A.P. allows engineers to insert capacitors requirements (Cap value, Frequency), producing Scattering Matrices (S2P) Charts while providing options (Case Size, Terminations, Mounting), and parameters (ESR, Q, Impedance) along with Datasheets. Once engineers have determined their capacitor requirements, C.A.P. also includes online Requests For Quotes (RFQs) and/or sample requests.

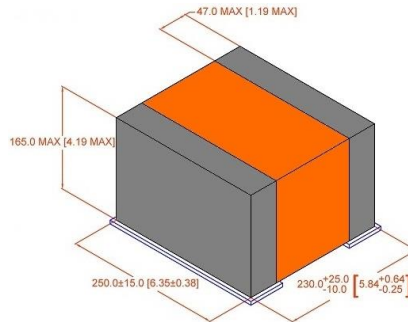

≠ Custom Assemblies

Passive Plus offers Capacitor Assemblies for high power requirements. Typical assemblies are configured in series and/or parallel combinations, producing higher voltage/current handling capabilities, extended capacitance range and tighter tolerances.

To get started, simply send us either a mechanical drawing or circuit conditions and we can recommend a solution. All components are 100% up-screened for Partial Discharge and Sonoscanned. All assemblies include a 100hr Military burn in.

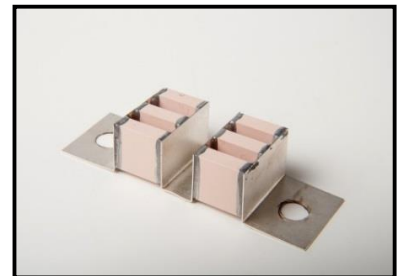

≠ Recommended Land Pattern Dimensions

When mounting the capacitor to substrate, it's important to carefully consider that the amount of solder (size of fillet) used has a direct effect upon the capacitor once it's mounted.

- 1) The greater the amount of solder, the greater the stress to the elements. This may cause the substrate to break or crack.
- 2) In the situation where two or more devices are mounted onto a common land, be sure to separate the device into exclusive pads by using soldering resist.

≠ Horizontal Mounting (mm)

A	B	C
3.9	2.5	7.0

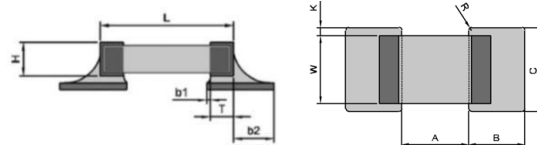

≠ Vertical Mounting (mm)

A	B	C
3.9	2.5	4.0

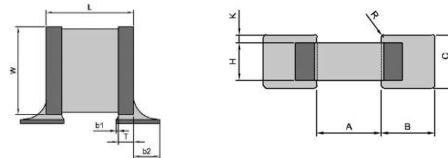

≠ Tape & Reel Specifications (mm)

Horizontal Orientation

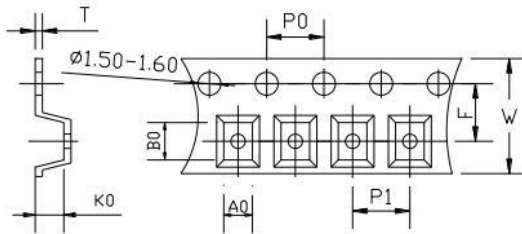

Orientation	W	P0	P1	T	F	Qty Min	Qty/reel	Tape Material
Horizontal	16.00	4.00	12.00	0.30	7.50	500	500	Plastic

A₀ B₀ K₀

- Determined by component size. Typical clearance between the cavity and the component is:
.05 (.002) min to .50 (.020) max for 8mm tape and .50 (.002) min to .65 (.026) max for 12mm tape.
- The component cannot rotate more than 20° within the determined cavity.



Traditional High Q (>10,000) Low ESR
Multi-Layer Ceramic Capacitors

3838C/P (0.380" x 0.380")

≠ Product Features

- High Q
- High RF Current/Voltage
- Ultra Stable Performance
- Capacitance Range:
0.5pF to 5100pF
- Working Voltage: 3600V
- Extended Voltage: 7200V

≠ Product Applications

Typical Functional Applications:

- Tuning • Bypass • Coupling
- D.C. Blocking • Impedance Matching

Typical Circuit Applications

- HF/ RF Power Amplifiers • Antenna Tuning • Plasma Chambers • Medical Equipment • Transmitters

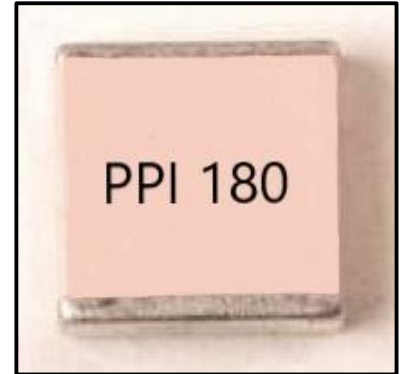

Marking shown for illustration purposes only. Actual marking may differ.

≠ Part Numbering

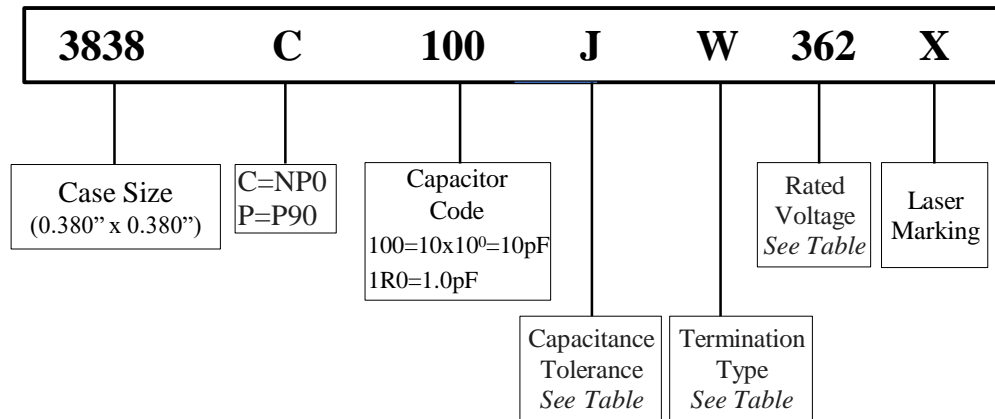

≠ Capacitance Tolerance Codes

Code	A	B	C	D	F	G	J	K
Tol.	±0.05pF	±0.1pF	±0.25pF	±0.5pF	±1%	±2%	±5%	±10%

≠ Voltage Codes

Voltage	Code
500V	501
1000V	102
2500V	252
3600V	362
7200V	722



Traditional High Q (>10,000) Low ESR
Multi-Layer Ceramic Capacitors

3838C/P (0.380" x 0.380")

≠ 3838C/P Capacitance Values

Special capacitances, tolerances and WVDC are available. Please contact PPI.

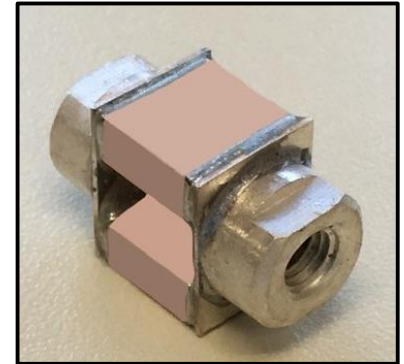

Cap. pF	Cap Code	Tol.	Rated WVDC		Cap. pF	Cap Code	Tol.	Rated WVDC		Cap. pF	Cap Code	Tol.	Rated WVDC		Cap. pF	Cap Code	Tol.	Rated WVDC			
			Std.	Ext.				Std.	Ext.				Std.	Ext.							
0.5	OR5	B,C, D	3600V	7200V	4.7	4R7	B,C, D	3600V	7200V	51	510	F,G, J,K	3600V	7200V	560	561	F,G, J,K	2500V			
0.6	OR6				5.1	5R1				56	560				620	621					
0.7	OR7				5.6	5R6				62	620				680	681					
0.8	OR8				6.2	6R2				68	680				750	751					
0.9	OR9				6.8	6R8				75	750				820	821					
1.0	1R0				7.5	7R5				82	820				910	911					
1.1	1R1				8.2	8R2	91	910	1000	102											
1.2	1R2				9.1	9R1	100	101	1100	112											
1.3	1R3				F,G, J,K	3600V	7200V	110	111	F,G, J,K	3600V				N/A	1200	122	F,G, J,K	1000V		
1.4	1R4							11	110							120	121			1500	152
1.5	1R5							12	120							130	131			1800	182
1.6	1R6							13	130							150	151			2200	222
1.7	1R7							15	150							160	161			2400	242
1.8	1R8							16	160							180	181			2700	272
1.9	1R9							18	180							200	201			3000	302
2.0	2R0							20	200							220	221			3300	332
2.1	2R1							22	220							240	241			3600	362
2.2	2R2							24	240							270	271			3900	392
2.4	2R4	27	270	300				301	4300			432									
2.7	2R7	30	300	330				331	4700			472									
3.0	3R0	33	330	360	361	5100	512														
3.3	3R3	36	360	390	391																
3.6	3R6	39	390	430	431																
3.9	3R9	43	430	470	471																
4.3	4R3	47	470	510	511																



Traditional High Q (>10,000) Low ESR
Multi-Layer Ceramic Capacitors

3838C/P (0.380" x 0.380")

≠ Termination Types and Codes

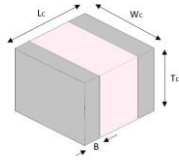

Chip Termination:
Codes: **W, L, P**

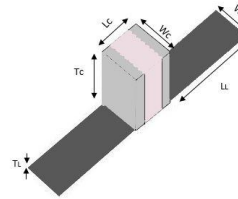

Microstrip Termination:
Codes: **MS, MN**

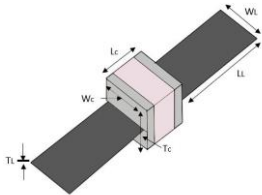

Axial Ribbon Termination:
Code: **AR, AN**

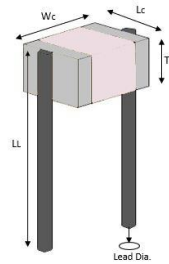

Radial Wire Termination:
Codes: **RW, RN**

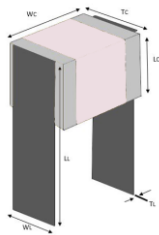

Radial Ribbon Termination:
Code: **RR, FN**

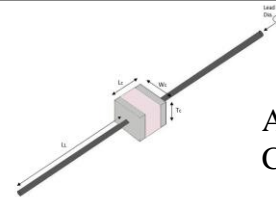

Axial Wire Termination:
Codes: **AW, BN**

Termination Code	Magnetic Termination
W	100% Sn Solder over Nickel Plating
L	90% Sn10%Pb Tin/Lead Solder over Nickel Plating
MS	
AR	
RR	Silver-Plated Copper
RW	
AW	

Termination Code	Non-Magnetic Terminations
P	100%Sn Solder over Copper Plating
MN	
AN	
FN	Silver-Plated Copper
RN	
BN	

Note: "Non-Magnetic" means no magnetic materials.



≠ Termination Types For Termination Types images, see previous page

Unit: inch (millimeter)

Magnetic Terminations								
Code	Term.	Capacitor Dimensions				Lead Dimensions		
		Length Lc	Width Wc	Thickness Tc	Overlap B	Length LL	Width WL	Thickness TL
W	Chip	0.380 -0.010+0.015 (9.65 - 0.25+0.38)	0.380 ±0.010 (9.65±0.25)	0.170 (4.32) max	0.024~0.059 (0.60~1.50)			
MS	Microstrip					0.728 (18.50) min	0.350 ± 0.020 (8.89±0.50)	0.008±0.001 (0.20±0.025)
AR	Axial Ribbon	0.380	0.380				0.315±0.010 (8.00±0.25)	
RR	Radial Ribbon	-0.010.+0.015	±0.010	0.177 (4.50) max		0.354 (9.00) min	0.118 ± 0.010 (3.0 ± 0.25)	0.012 ± 0.001 (0.3 ± 0.025)
RW	Radial Wire	(9.65 -0.25+0.38)	(9.65 ±0.25)			0.709 (18.00) min	Dia.: 0.031±0.004 (0.80 ± 0.10)	
AW	Axial Wire					0.906 (23.00) min		

⊗ Non-Magnetic Termination: ⊗								
Code	Term.	Capacitor Dimensions				Lead Dimensions		
		Length Lc	Width Wc	Thickness Tc	Overlap B	Length LL	Width WL	Thickness TL
P	Chip	0.380 -0.010+0.015 (9.65 - 0.25+0.38)	0.380 ±0.010 (9.65±0.25)	0.170 (4.32) max	0.024~0.059 (0.60~1.50)			
MN	Microstrip					0.728 (18.50) min	0.350 ± 0.020 (8.89±0.50)	0.008 ± 0.001 (0.20 ± 0.025)
AN	Axial Ribbon	0.380	0.380				0.315±0.010 (8.00±0.25)	
FN	Radial Ribbon	-0.010+0.015	±0.010	0.177 (4.50) max		0.354 (9.00) min	0.118 ± 0.010 (3.0 ± 0.25)	0.012 ± 0.001 (0.3 ± 0.025)
RN	Radial Wire	(9.65 -0.25+0.38)	(9.65 ±0.25)			0.709 (18.00) min	Dia.: 0.031 ± 0.004 (0.80 ± 0.10)	
BN	Axial Wire					0.906 (23.00) min		

Note: Non-Magnetic means no magnetic materials. All leads are attached with high temperature solder and parts are RoHS Compliant.



⚡ Electrical Specifications

Quality Factor (Q)	Greater than 10,000 at 1 MHz
Insulation Resistance (IR)	Test Voltage: 500V 10 ⁵ Megaohms min. @ +25°C rated WVDC 10 ⁴ Megaohms min. @ +125°C rated WVDC
Rated Voltage	See Rated Voltage Table
Dielectric Withstanding Voltage (WVDC)	250% of Rated Voltage of 5 seconds, Rated Voltage ≤ 500VDC 150% of Voltage for 5 seconds, 500VDC < Rated Voltage ≤ 1250 VDC 120% of Voltage for 5 seconds, Rated Voltage > 1250 VDC
Operating Temperature Range	-55°C to 200°C
Temperature Coefficient (TC)	C: -55°C to 125°C 0±30ppm/°C; >125°C to 200°C 0±60ppm/°C P: -55°C to 200°C +90±20ppm/°C
Capacitance Drift	±0.02% or ±0.02pF, whichever is greater
Piezoelectric Effects	None
Termination Type	See Termination Type Table

⚡ Environmental Specifications

	Specification	Test Parameters
Thermal Shock	DWV: The initial value IR: Shall not be less than 30% of the initial value. Capacitance Change:	MIL-STD-202, Method 107, Condition A. At the maximum rated temperature (-55°C and 200°C) stay 30 minutes, the time of removing shall not be more than 3 minutes. Perform five cycles.
Moisture Resistance	No more than 0.5% or 0.5pF, whichever is greater.	MIL-STD-202, Method 106
Humidity (Steady State)	DWV: The initial value IR: The initial value Capacitance Change: No more than 0.3% or 0.3pF, whichever is greater.	MIL-STD-202, Method 103, Condition A With 1.5Volts DC applied while subjected to an environment of 85°C with 85% relative humidity for 240 hours minimum.
Life	IR: Shall not be less than 30% of the initial value. Capacitance Change: No more than 2.0% or 0.5pF, whichever is greater.	MIL-STD-202, Method 108. For 2000 hours, at 200°C. 200% of Voltage for Capacitors, Rated Voltage ≤ 500VDC; 120% of Voltage for Capacitors, 500VDC < Rated Voltage ≤ 1250VDC; 100% for Voltage for Capacitors, Rated Voltage > 1250VDC
Terminal Strength	Force: 20lbs typical, 10lbs. min. Duration Time: 5 to 10 seconds	MIL-STD-202, Method 211A, Test Condition A. Applied a force and maintained for a period of 5 to 10 seconds. The force shall be in the direction of the axes of the terminations.

Capacitors are designed and manufactured to meet the requirements of MIL-PRF-55681 and MIL-PRF-123.



Traditional High Q (>10,000) Low ESR
Multi-Layer Ceramic Capacitors

3838C/P (0.380" x 0.380")

≡ Series Resonance vs. Capacitance

Series Resonance vs. Capacitance

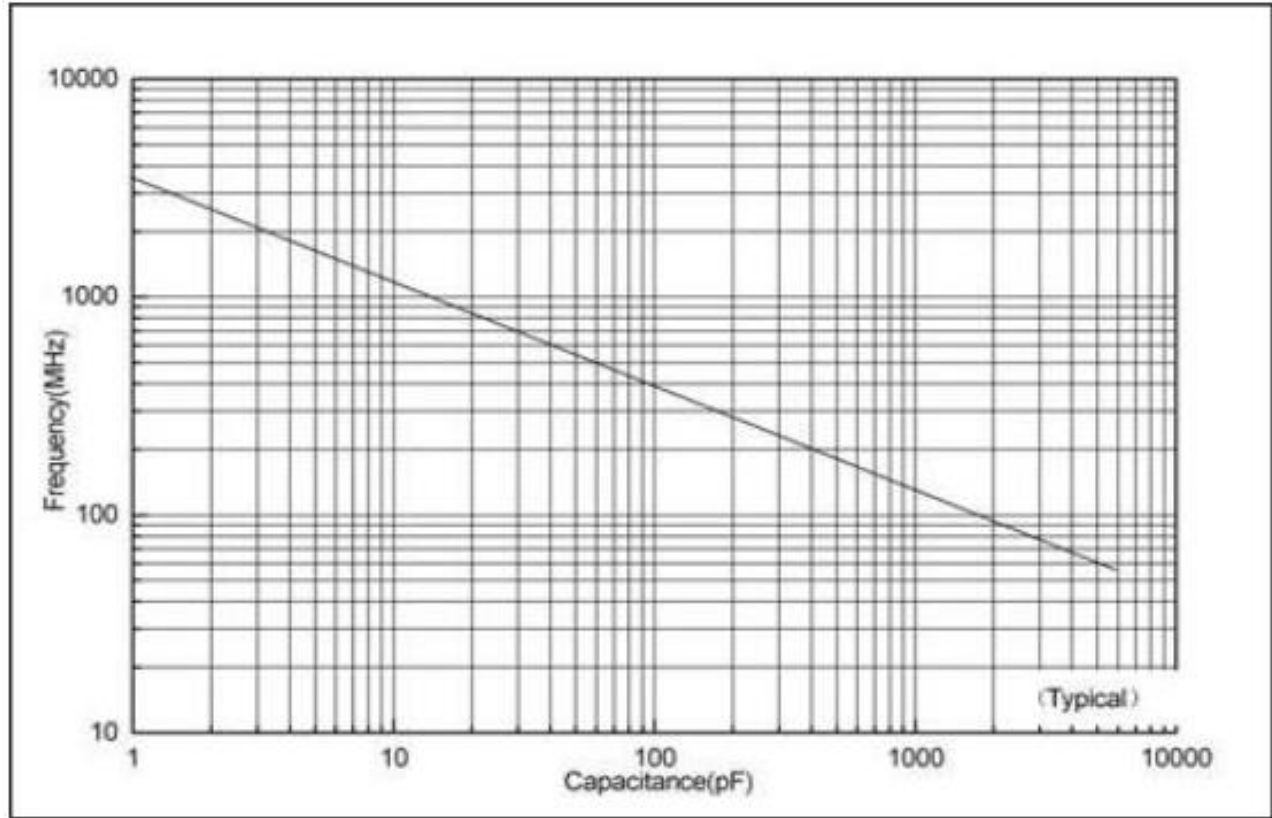



Traditional High Q (>10,000) Low ESR
Multi-Layer Ceramic Capacitors

3838C/P (0.380" x 0.380")

≠ ESR vs. Frequency

ESR vs Frequency

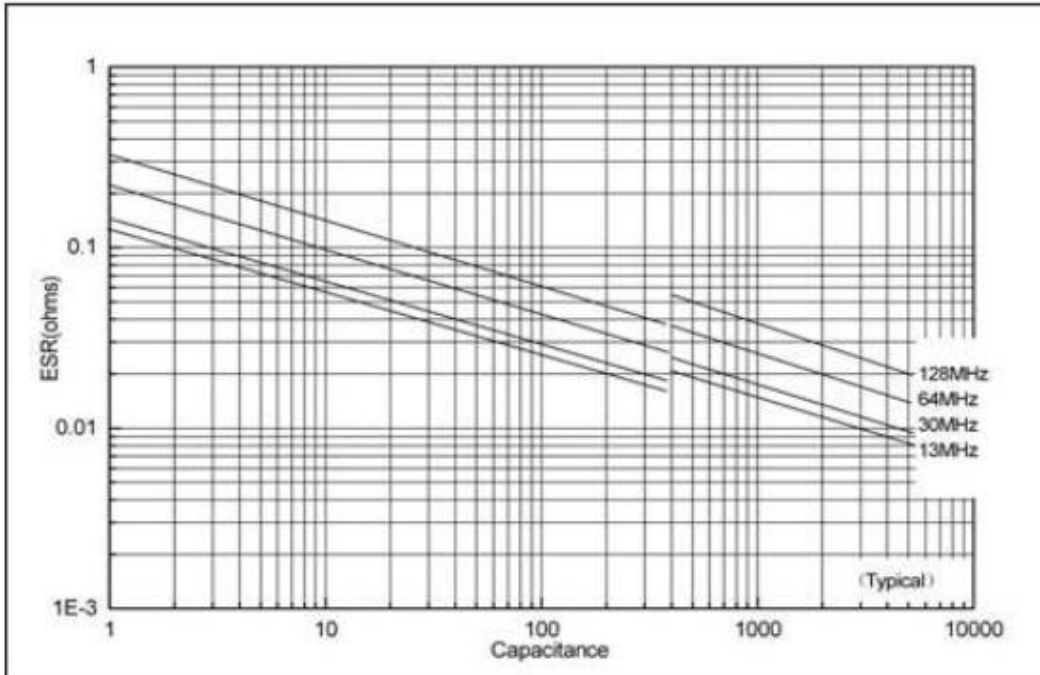

≠ Q vs. Capacitance

Q vs Capacitance

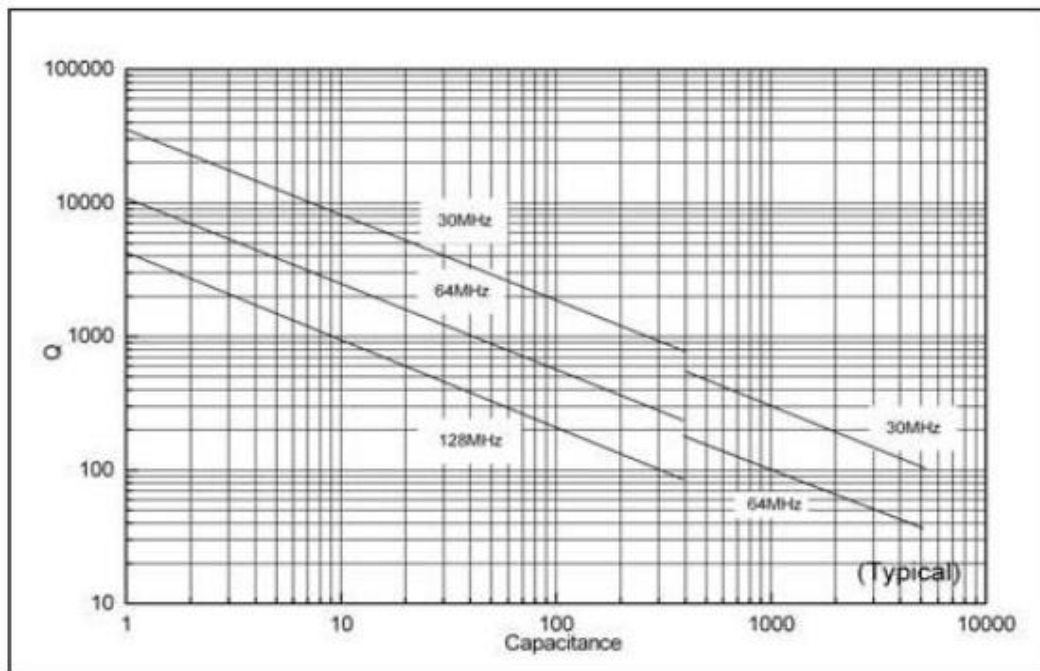

≠ Current Rating vs. Capacitance

3838C/P Current Rating vs Capacitance

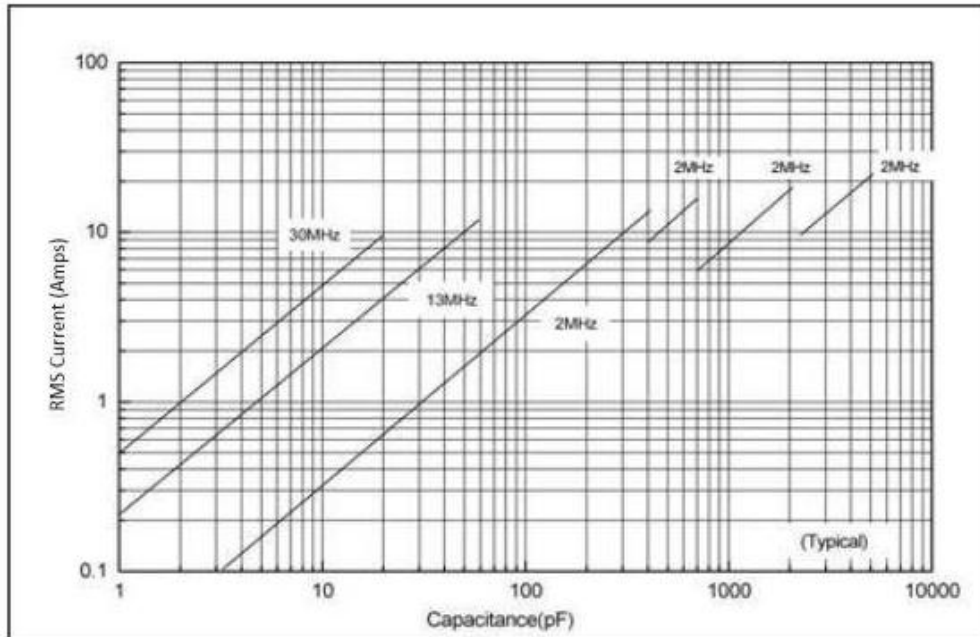

The current depends on voltage limited:

$$I = \frac{\sqrt{2}}{2} I_{peak} = \frac{\sqrt{2}}{2} \times \frac{V_{rated}}{X_C} = \sqrt{2\pi f C V_{rated}}$$

The current depends on power dissipation limited:

$$I = \sqrt{\frac{P_{dissipation}}{ESR}}$$

Note: If the thermal resistance of mounting surface is 12°C/W, then a power dissipation of 5W will result in the current limited. We can calculate the current limited.

≠ Custom Assemblies

Passive Plus offers Capacitor Assemblies for high power requirements. Typical assemblies are configured in series and/or parallel combinations, producing higher voltage/current handling capabilities, extended capacitance range and tighter tolerances.

To get started, simply send us either a mechanical drawing or circuit conditions and we can recommend a solution. All components are 100% up-screened for Partial Discharge and Sonoscanned. All assemblies include a 100hr Military burn in.

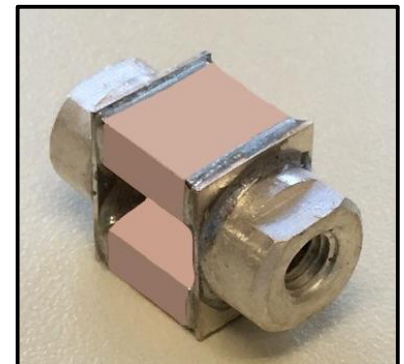

≠ Recommended Land Pattern Dimensions

When mounting the capacitor to substrate, it's important to carefully consider that the amount of solder (size of fillet) used has a direct effect upon the capacitor once it's mounted.

- 1) The greater the amount of solder, the greater the stress to the elements. This may cause the substrate to break or crack.
- 2) In the situation where two or more devices are mounted onto a common land, be sure to separate the device into exclusive pads by using soldering resist.

≠ Horizontal Mounting (mm)

A	B	C
7.1	3.0	10.2

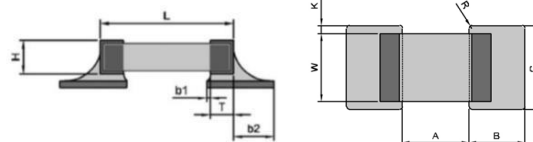

≠ Vertical Mounting* (mm)

A	B	C
7.1	3.0	5.0

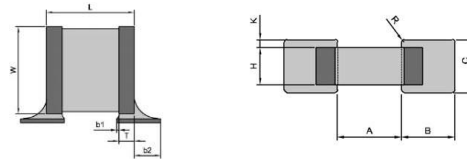

≠ Tape & Reel Specifications (mm)

Horizontal Orientation

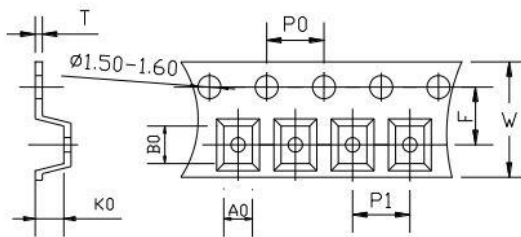

Orientation	W	P0	P1	T	F	Qty/Min	Qty/reel	Tape Material
Horizontal	16.00	4.00	12.00	0.30	7.50	50	200	Plastic

A₀ B₀ K₀

- Determined by component size. Typical clearance between the cavity and the component is:
.05 (.002) min to .50 (.020) max for 8mm tape and .50 (.002) min to .65 (.026) max for 12mm tape.
- The component cannot rotate more than 20° within the determined cavity.



UHF/RF High Q Power Transmitter
Capacitors (NP0 TC)
Multi-Layer Ceramic Capacitors

6040C (0.600" x 0.400")

≠ **Product Features**

- High Q
- High RF Current/Voltage
- Ultra Stable Performance
- Capacitance Range:
1.0pF to 6800pF
- Working Voltage: 5000V
- Extended Voltage: 8000V

≠ **Typical Circuit Applications**

- Semiconductor Manufacturing
- High Energy Power Transfers
- Plasma Chambers
- Medical Equipment



Marking shown for illustration purposes only.
Actual marking may differ.

≠ **Part Numbering**

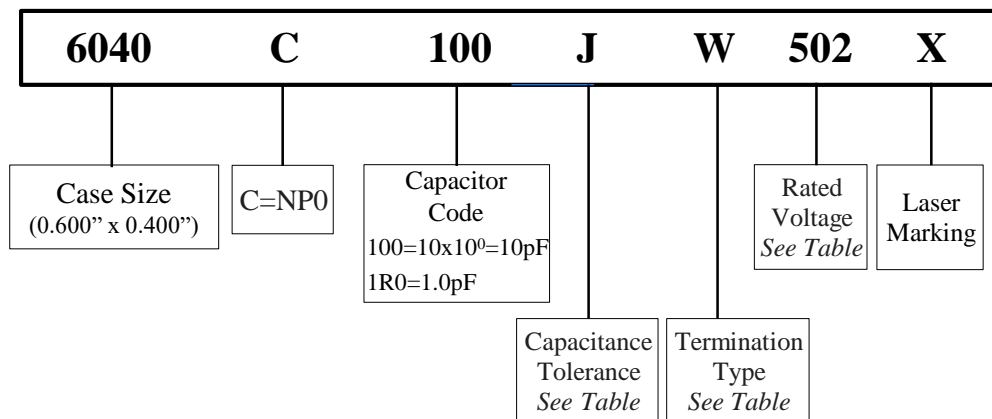

≠ **Capacitance Tolerance Codes**

Code	B	C	D	F	G	J	K
Tol.	±0.1pF	±0.25pF	±0.5pF	±1%	±2%	±5%	±10%

≠ **Voltage Codes**

Voltage	Code
1000V	102
2000V	202
3000V	302
5000V	502
8000V	802



UHF/RF High Q Power Transmitter
Capacitors (NP0 TC)
Multi-Layer Ceramic Capacitors

6040C (0.600" x 0.400")

≠ 6040C Capacitance Values

For special capacitances, tolerances and WVDC, please contact PPI.



Marking shown for illustration purposes only.
Actual marking may differ.

Cap. pF	Cap Code	Tol.	Rated WVDC		Cap. pF	Cap Code	Tol.	Rated WVDC		Cap. pF	Cap Code	Tol.	Rated WVDC	
			Std.	Ext.				Std.	Ext.				Std.	Ext.
1.0	1R0				39	390				1500	152			
1.2	1R2				47	470				1800	182	F,G, J,K	2000V	3000V
1.5	1R5				56	560	F,G, J,K	5000V	8000V	2200	222			
1.8	1R8				68	680				2700	272			
2.2	2R2				82	820				3300	332			
2.7	2R7	B,C, D	5000V	8000V	100	101				4700	472	F,G, J,K	1000V	2000V
3.3	3R3				120	121				5100	512			
3.9	3R9				150	151				5600	562			
4.7	4R7				180	181				6800	682			
5.6	5R6				220	221								
6.8	6R8				270	271	F,G, J,K	3000V	5000V					
8.2	8R2				330	331								
10	100				390	391								
12	120				470	471								
15	150				560	561								
18	180	F,G, J,K	5000V	8000V	680	681								
22	220				820	821								
27	270				1000	102	F,G, J,K	2000V	3000V					
33	330				1200	122								

≠ Termination Types and Codes

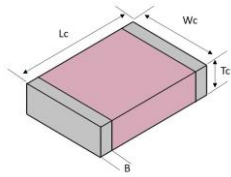

Chip Termination:
Codes: **W, L, P**

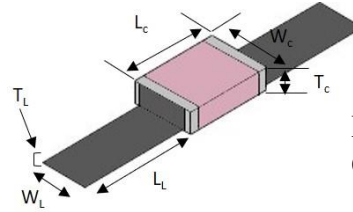

Microstrip Termination:
Codes: **MS, MN**

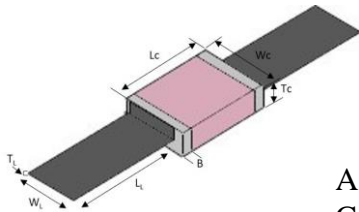



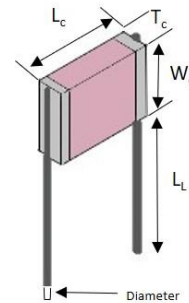

Axial Ribbon Termination:
Code: **AR, AN**

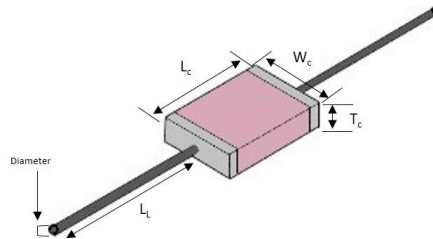





Radial Wire Termination:
Codes: **RW, RN**



Axial Wire Termination:
Codes: **AW, BN**

Termination Code	Magnetic Termination
W 	100% Sn Solder over Nickel Plating
L	90% Sn10%Pb Tin/Lead Solder over Nickel Plating
MS 	Silver-Plated Copper
AR 	
RW 	
AW 	

Termination Code	Non-Magnetic Terminations
P 	100% Sn Solder over Copper Plating
MN 	Silver-Plated Copper
AN 	
RN 	
BN 	

Note: "Non-Magnetic" means no magnetic materials.



≠ Terminations For Termination Types images, see previous page

Unit: inch (millimeter)

Magnetic Terminations								
		Capacitor Dimensions				Lead Dimensions		
Code	Term.	Length Lc	Width Wc	Thickness Tc	Overlap B	Length LL	Width WL	Thickness TL
W	Chip	0.614 -0.010+0.015 (15.6 -0.25+0.38)	0.433±0.010 (11.0±0.25)	0.154±0.008 (3.90±0.20) max	0.063 (1.60) max	-	-	-
MS	Microstrip					0.787 (20.0) min	0.350 ± 0.010 (8.89±0.25)	0.008±0.001 (0.20± 0.025)
AR	Axial Ribbon	0.614 -0.010+0.015	0.433±0.010 (11.0±0.25)	0.154±0.008 (3.90±0.20) max	-	0.787 (20.00) min	Dia.: 0.030±0.004 (0.80 ± 0.10)	
RW	Radial Wire	(15.6 -0.25+0.38)				0.984 (25.00) min		
AW	Axial Wire							

⊘ Non-Magnetic Terminations ⊘								
		Capacitor Dimensions				Lead Dimensions		
Code	Term.	Length Lc	Width Wc	Thickness Tc	Overlap B	Length LL	Width WL	Thickness TL
P	Chip	0.614 -0.010+0.015 (15.6 -0.25+0.38)	0.433±0.010 (11.0±0.25)	0.154±0.008 (3.90±0.20) max	0.063 (1.60) max	-	-	-
MN	Microstrip					0.787 (20.0) min	0.350 ± 0.010 (8.89±0.25)	0.008 ±0.001 (0.20 ± 0.025)
AN	Axial Ribbon	0.614 -0.010+0.015	0.433±0.010 (11.0±0.25)	0.154±0.008 (3.90±0.20) max	-	0.787 (20.00) min	Dia.: 0.031 ±0 .004 (0.80 ± 0.10)	
RN	Radial Wire	(15.6 -0.25+0.38)				0.984 (25.00) min		
BN	Axial Wire							

Note: Non-Magnetic means no magnetic materials. All leads are attached with high temperature solder and parts are RoHS Compliant.



⚡ Electrical Specifications

Quality Factor (Q)	No less than 1000pF, Q value more than 2000, Test Frequency 1MHz; More than 1000pF, Q value more than 2000, Test Frequency 1MHz
Insulation Resistance (IR)	Test Voltage: 500V 10 ⁵ Megaohms min. @ +25°C rated WVDC 10 ⁴ Megaohms min. @ +125°C rated WVDC
Rated Voltage	See Rated Voltage Table
Dielectric Withstanding Voltage (WVDC)	250% of Voltage of 5 seconds, Rated Voltage ≤ 500VDC 150% of Voltage for 5 seconds, 500VDC < Rated Voltage ≤ 1250 VDC 120% of Voltage for 5 seconds, Rated Voltage > 1250 VDC
Operating Temperature Range	-55°C to 175°C
Temperature Coefficient (TC)	-55°C to 125°C 0±30ppm/°C >125°C to 175°C 0±60ppm/°C
Capacitance Drift	±0.02% or ±0.02pF, whichever is greater
Piezoelectric Effects	None
Termination Type	See Termination Type Table

⚡ Environmental Specifications

	Specification	Test Parameters
Thermal Shock	DWV: The initial value IR: Shall not be less than 30% of the initial value. Capacitance Change:	MIL-STD-202, Method 107, Condition A. At the maximum rated temperature (-55°C and 175°C) stay 30 minutes, the time of removing shall not be more than 3 minutes. Perform five cycles.
Moisture Resistance	No more than 0.5% or 0.5pF, whichever is greater.	MIL-STD-202, Method 106
Humidity (Steady State)	DWV: The initial value IR: The initial value Capacitance Change: No more than 0.3% or 0.3pF, whichever is greater.	MIL-STD-202, Method 103, Condition A With 1.5Volts DC applied while subjected to an environment of 85°C with 85% relative humidity for 240 hours minimum.
Life	IR: Shall not be less than 30% of the initial value. Capacitance Change: No more than 2.0% or 0.5pF, whichever is greater.	MIL-STD-202, Method 108. For 2000 hours, at 125°C. 200% of Voltage for Capacitors, Rated Voltage ≤ 500VDC; 120% of Voltage for Capacitors, 500VDC < Rated Voltage ≤ 1250VDC; 100% for Voltage for Capacitors, Rated Voltage > 1250VDC
Terminal Strength	Force: 25lbs typical, 20lbs. min. Duration Time: 5 to 10 seconds	MIL-STD-202, Method 211A, Test Condition A. Applied a force and maintained for a period of 5 to 10 seconds. The force shall be in the direction of the axes of the terminations.

Capacitors are designed and manufactured to meet the requirements of MIL-PRF-55681 and MIL-PRF-123.

≠ ESR vs. Capacitance Measured @ 30MHz

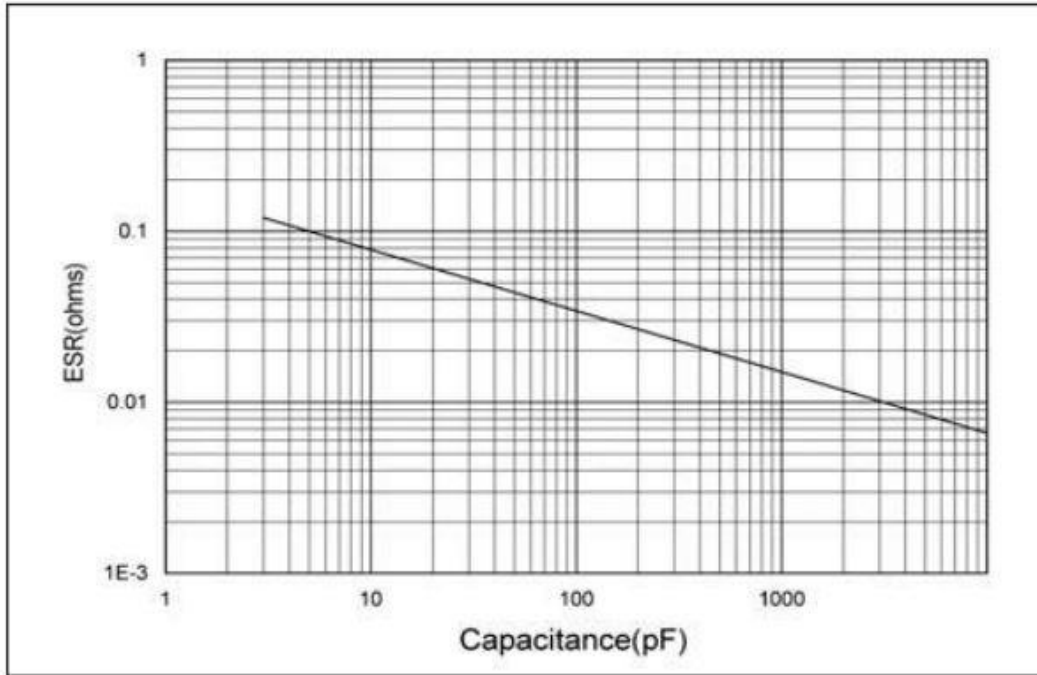

≠ Self Resonant Frequency vs. Capacitance

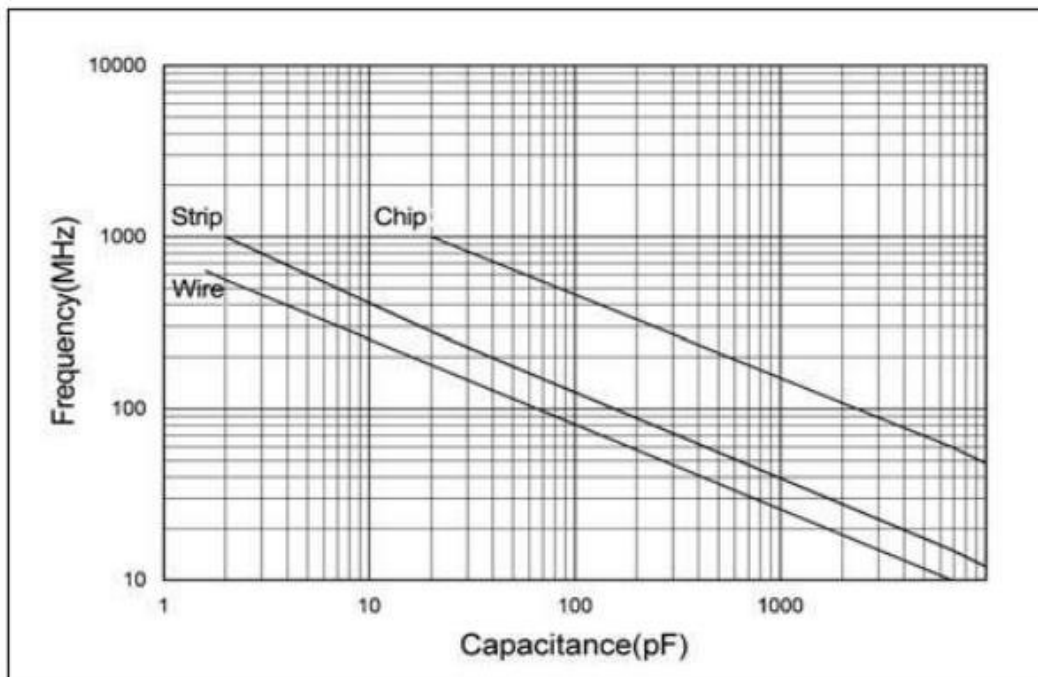

≠ Strip Terminals Rated Current vs. Frequency

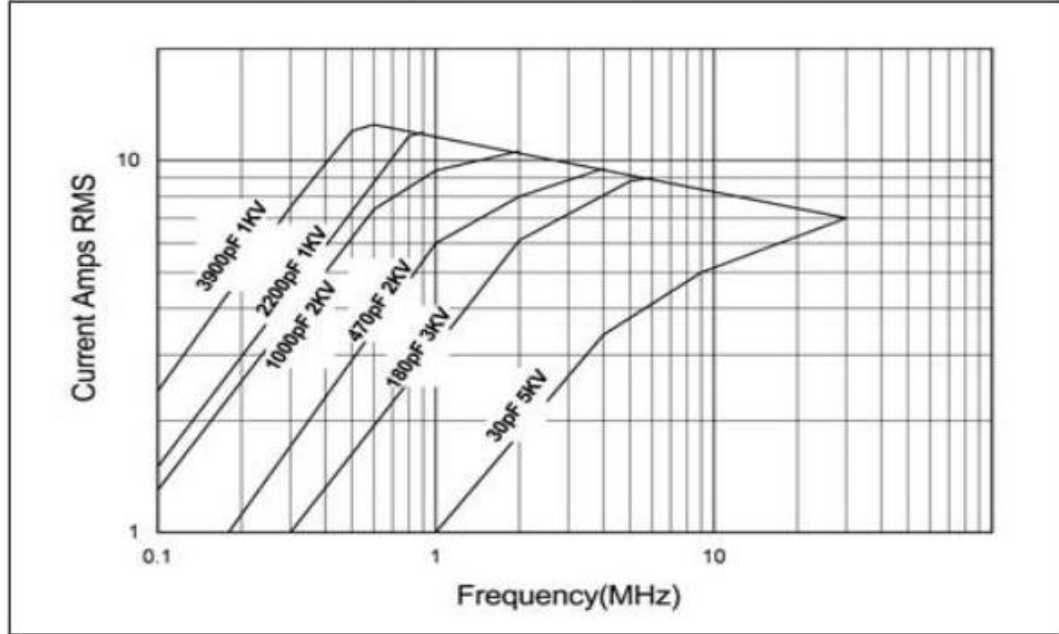

≠ Wire Terminals Rated Current vs. Frequency

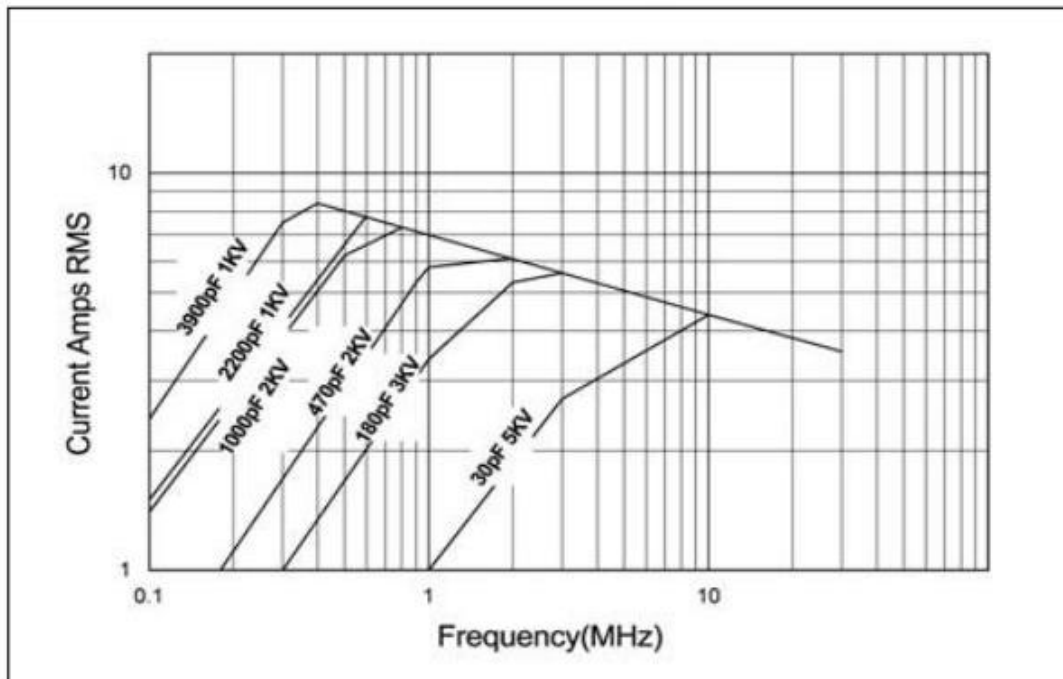

≠ % Maximum Current vs. Ambient Temperature

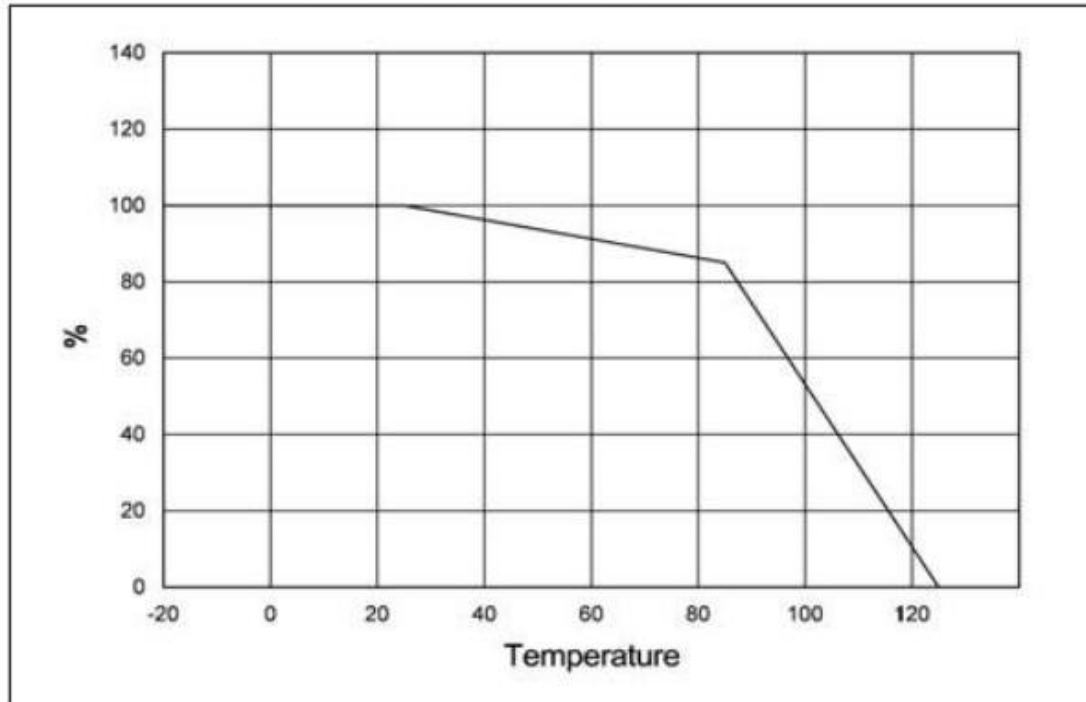

≠ Custom Assemblies

Passive Plus offers Capacitor Assemblies for high power requirements. Typical assemblies are configured in series and/or parallel combinations, producing higher voltage/current handling capabilities, extended capacitance range and tighter tolerances.

To get started, simply send us either a mechanical drawing or circuit conditions and we can recommend a solution. All components are 100% up-screened for Partial Discharge and Sonoscanned. All assemblies include a 100hr Military burn in.

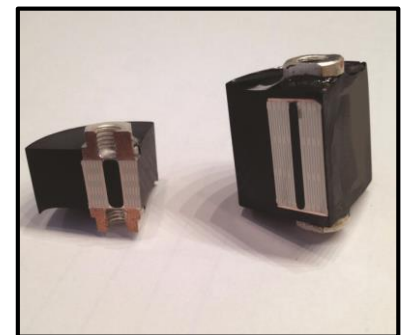

⚡ Recommended Land Pattern Dimensions

When mounting the capacitor to substrate, it's important to carefully consider that the amount of solder (size of fillet) used has a direct effect upon the capacitor once it's mounted.

- 1) The greater the amount of solder, the greater the stress to the elements. This may cause the substrate to break or crack.
- 2) In the situation where two or more devices are mounted onto a common land, be sure to separate the device into exclusive pads by using soldering resist.

⚡ Horizontal Mounting

A	B	C
13.00	3.30	11.30

Dimensions: mm

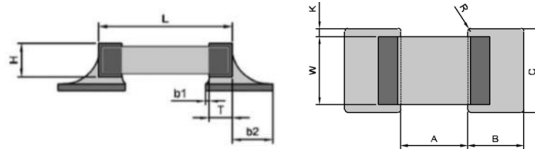



UHF/RF High Q Power Transmitter
Capacitors (NP0 TC)
Multi-Layer Ceramic Capacitors

7676C (0.760" x 0.760")

⚡ Product Features

- High Q
- High RF Current/Voltage
- Ultra Stable Performance
- Capacitance Range:
1.0pF to 20000pF
- Working Voltage: 5000V
- Extended Voltage: 8000V

⚡ Typical Circuit Applications

- Semiconductor Manufacturing
- High Energy Power Transfers
- Plasma Chambers
- Medical Equipment

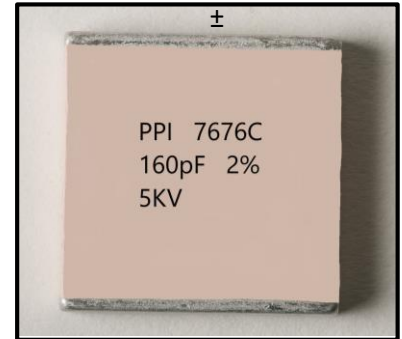

Marking shown for illustration purposes only.
Actual marking may differ.

⚡ Part Numbering

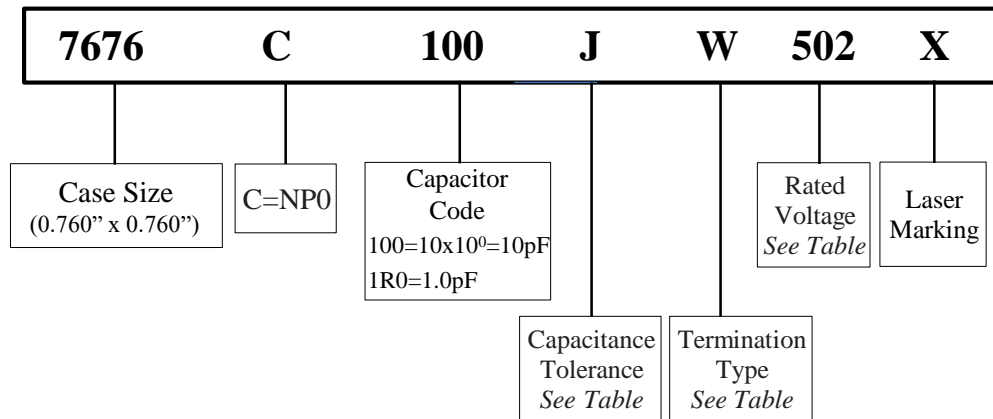

⚡ Capacitance Tolerance Codes

Code	B	C	D	F	G	J	K
Tol.	±0.1pF	±0.25pF	±0.5pF	±1%	±2%	±5%	±10%

⚡ Voltage Codes

Voltage	Code
1000V	102
2000V	202
3000V	302
5000V	502
8000V	802



UHF/RF High Q Power Transmitter
Capacitors (NP0 TC)
Multi-Layer Ceramic Capacitors

7676C (0.760" x 0.760")

≠ 7676C Capacitance Values

Special capacitances, tolerances and WVDC are available. Please contact PPI.

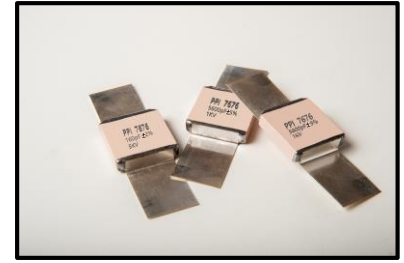

Marking shown for illustration purposes only.
Actual marking may differ.

Cap. pF	Cap Code	Tol.	Rated WVDC		Cap. pF	Cap Code	Tol.	Rated WVDC		Cap. pF	Cap Code	Tol.	Rated WVDC	
			Std.	Ext.				Std.	Ext.				Std.	Ext.
1.0	1R0				33	330				1000	102			
1.2	1R2				39	390				1200	122			
1.5	1R5				47	470				1500	152			
1.8	1R8				56	560				1800	182			
2.2	2R2				68	680				2200	222	G,J, K	3000V	5000V
2.7	2R7	B,C, D	5000V	8000V	82	820	F,G, J,K	5000V	8000V	2700	272			
3.3	3R3				100	101				3300	332			
3.9	3R9				120	121				4700	472			
4.7	4R7				150	151				5100	512			
5.6	5R6				180	181				5600	562			
6.8	6R8				220	221				6800	682	G,J, K	1000V	3000V
8.2	8R2				270	271				7500	752			
10	100				300	301				8200	822			
12	120				390	391				10000	103			
15	150	F,G, J,K	5000V	8000V	470	471	F,G, J,K	3000V	5000V	12000	123			
18	180				560	561				15000	153	G,J, K	1000V	2000V
22	220				680	681				18000	183			
27	270				820	821				20000	203			

≠ Termination Types and Codes

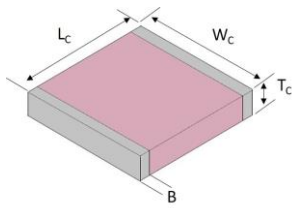

Chip Termination:
Codes: **W, L, P**

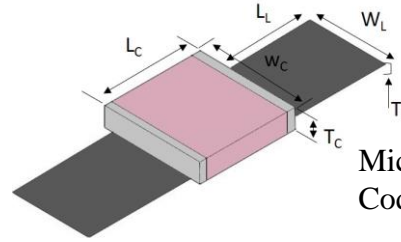

Microstrip Termination:
Codes: **MS, MN**

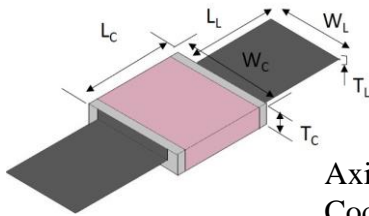



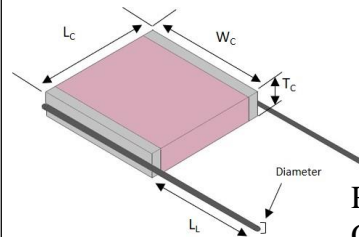

Axial Ribbon Termination:
Code: **AR, AN**

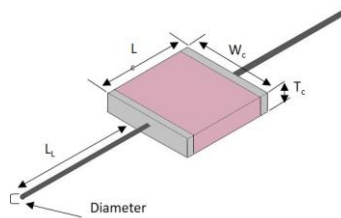





Radial Wire Termination:
Codes: **RW, RN**



Axial Wire Termination:
Codes: **AW, BN**

Termination Code	Magnetic Termination
W 	100% Sn Solder over Nickel Plating
L	90% Sn10%Pb Tin/Lead Solder over Nickel Plating
MS 	
AR 	
RW 	Silver-Plated Copper
AW 	

Termination Code	Non-Magnetic Terminations
P 	100% Sn Solder over Copper Plating
MN 	
AN 	
RN 	Silver-Plated Copper
BN 	

Note: "Non-Magnetic" means no magnetic materials.



≠ Termination Types For Termination Types images, see previous page

Unit: inch (millimeter)

Magnetic Terminations								
		Capacitor Dimensions				Lead Dimensions		
Code	Term.	Length Lc	Width Wc	Thickness Tc	Overlap B	Length LL	Width WL	Thickness TL
W	Chip					-	-	-
MS	Microstrip	0.760	0.760±0.010	0.154±0.008	0.063	0.787	0.591 ± 0.010	0.008±0.001
AR	Axial Ribbon	-0.010+0.015 (19.3 -0.25+0.38)	(19.3±0.25)	(3.90±0.20) max	(1.60) max	(20.0) min	(15.0±0.25)	(0.20± 0.025)
RW	Radial Wire					0.787 (20.00) min	Dia.: 0.030±0.004 (0.80 ± 0.10)	
AW	Axial Wire					1.181 (30.00) min		

⊗ Non-Magnetic Terminations ⊗								
		Capacitor Dimensions				Lead Dimensions		
Code	Term.	Length Lc	Width Wc	Thickness Tc	Overlap B	Length LL	Width WL	Thickness TL
P	Chip					-	-	-
MN	Microstrip	0.760	0.760±0.010	0.154±0.008	0.063	0.787	0.591 ± 0.010	0.008 ± 0.001
AN	Axial Ribbon	-0.010+0.015 (19.3 -0.25+0.38)	(19.3±0.25)	(3.90±0.20) max	(1.60) max	(20.0) min	(15.0±0.25)	(0.20 ± 0.025)
RN	Radial Wire					0.787 (20.00) min	Dia.: 0.031 ± 0.004 (0.80 ± 0.10)	
BN	Axial Wire					1.181 (30.00) min		

Note: Non-Magnetic means no magnetic materials. All leads are attached with high temperature solder and parts are RoHS Compliant.



≠ Electrical Specifications

Quality Factor (Q)	No less than 1000pF, Q value more than 2000, Test Frequency 1MHz; More than 1000pF, Q value more than 2000, Test Frequency 1MHz
Insulation Resistance (IR)	Test Voltage: 500V 10 ⁵ Megaohms min. @ +25°C rated WVDC 10 ⁴ Megaohms min. @ +125°C rated WVDC
Rated Voltage	See Rated Voltage Table
Dielectric Withstanding Voltage (WVDC)	250% of Voltage of 5 seconds, Rated Voltage ≤ 500VDC 150% of Voltage for 5 seconds, 500VDC < Rated Voltage ≤ 1250 VDC 120% of Voltage for 5 seconds, Rated Voltage > 1250 VDC
Operating Temperature Range	-55°C to 175°C
Temperature Coefficient (TC)	-55°C to 125°C 0±30ppm/°C >125°C to 175°C 0±60ppm/°C
Capacitance Drift	±0.02% or ±0.02pF, whichever is greater
Piezoelectric Effects	None
Termination Type	See Termination Type Table

≠ Environmental Specifications

	Specification	Test Parameters
Thermal Shock	DWV: The initial value IR: Shall not be less than 30% of the initial value. Capacitance Change:	MIL-STD-202, Method 107, Condition A. At the maximum rated temperature (-55°C and 175°C) stay 30 minutes, the time of removing shall not be more than 3 minutes. Perform five cycles.
Moisture Resistance	No more than 0.5% or 0.5pF, whichever is greater.	MIL-STD-202, Method 106
Humidity (Steady State)	DWV: The initial value IR: The initial value Capacitance Change: No more than 0.3% or 0.3pF, whichever is greater.	MIL-STD-202, Method 103, Condition A With 1.5Volts DC applied while subjected to an environment of 85°C with 85% relative humidity for 240 hours minimum.
Life	IR: Shall not be less than 30% of the initial value. Capacitance Change: No more than 2.0% or 0.5pF, whichever is greater.	MIL-STD-202, Method 108. For 2000 hours, at 125°C. 200% of Voltage for Capacitors, Rated Voltage ≤ 500VDC; 120% of Voltage for Capacitors, 500VDC < Rated Voltage ≤ 1250VDC; 100% for Voltage for Capacitors, Rated Voltage > 1250VDC
Terminal Strength	Force: 30lbs. min. Duration Time: 5 to 10 seconds	MIL-STD-202, Method 211A, Test Condition A. Applied a force and maintained for a period of 5 to 10 seconds. The force shall be in the direction of the axes of the terminations.

Capacitors are designed and manufactured to meet the requirements of MIL-PRF-55681 and MIL-PRF-123.

≠ ESR vs. Capacitance Measured @ 30MHz

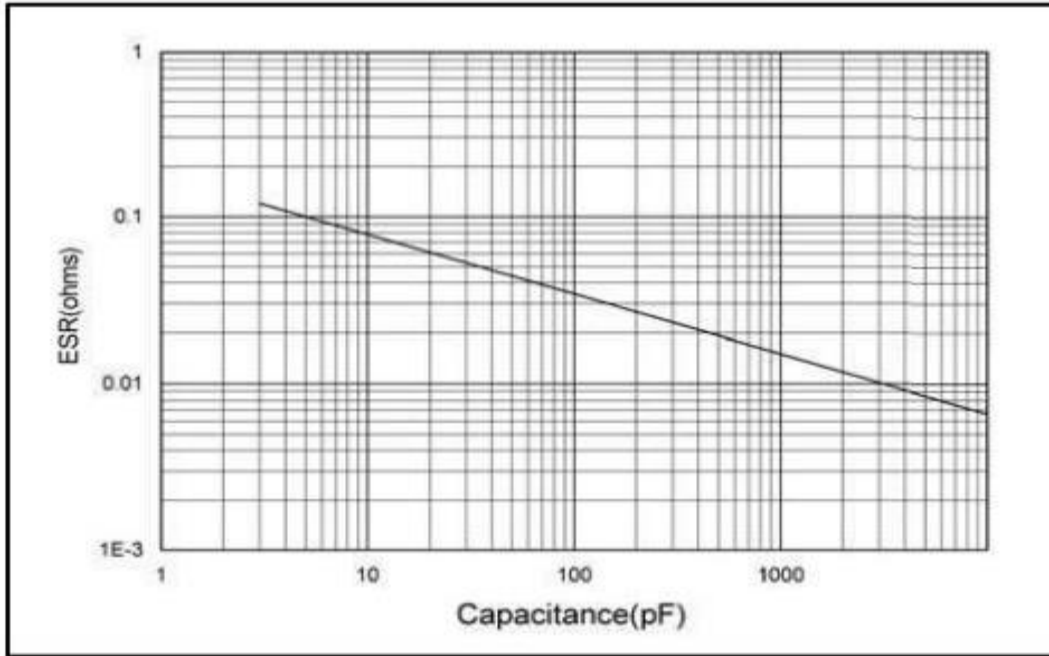

≠ Self Resonant Frequency vs. Capacitance

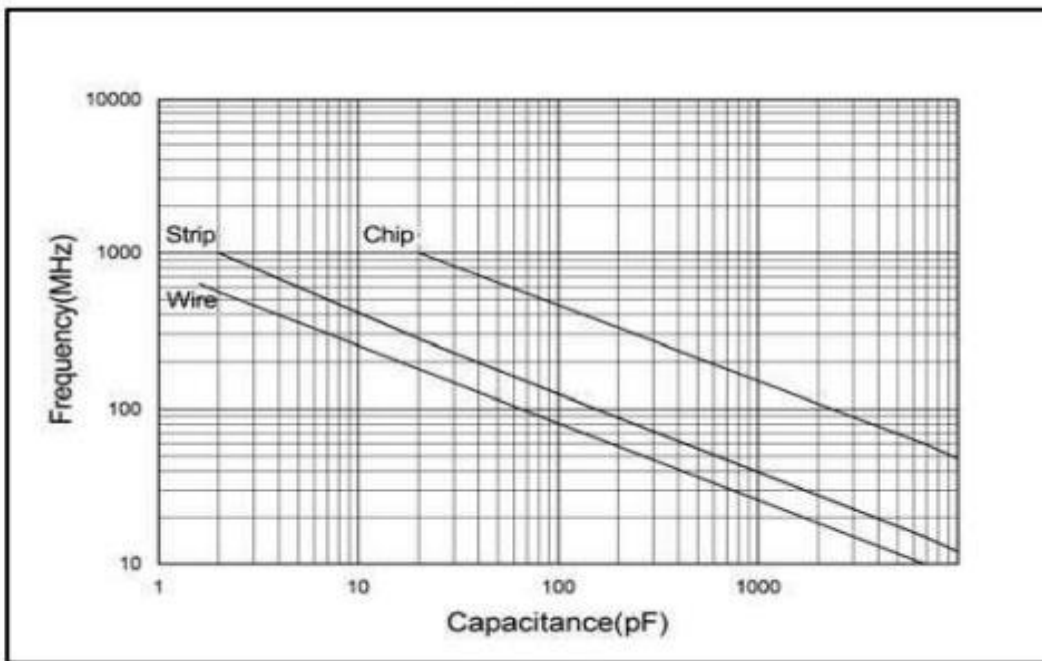

≠ Strip Terminals Rated Current vs. Frequency

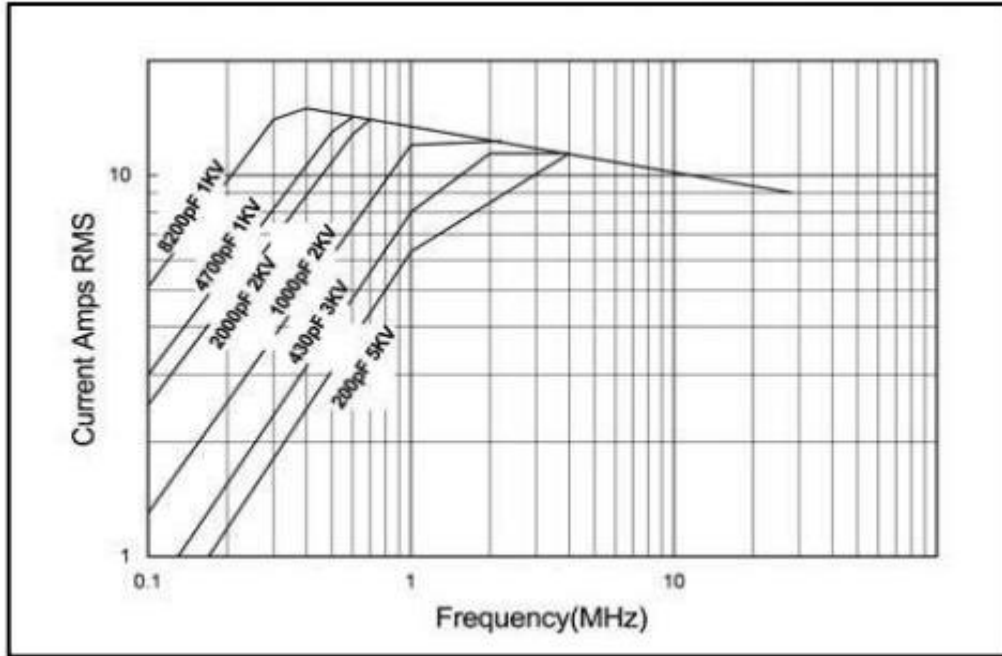

≠ Wire Terminals Rated Current vs. Frequency

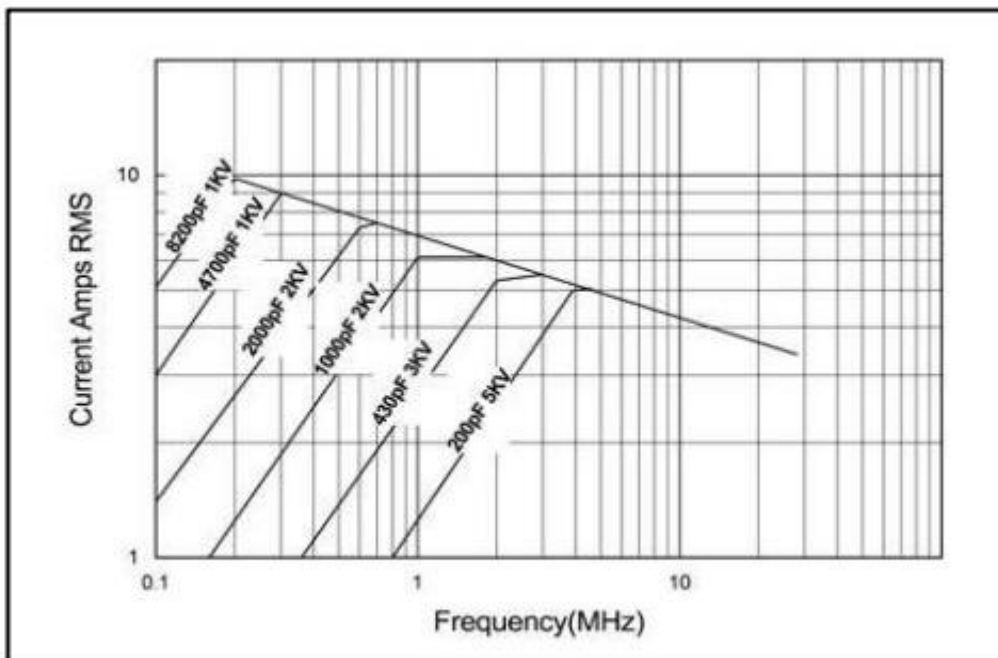

≠ % Maximum Current vs. Ambient Temperature

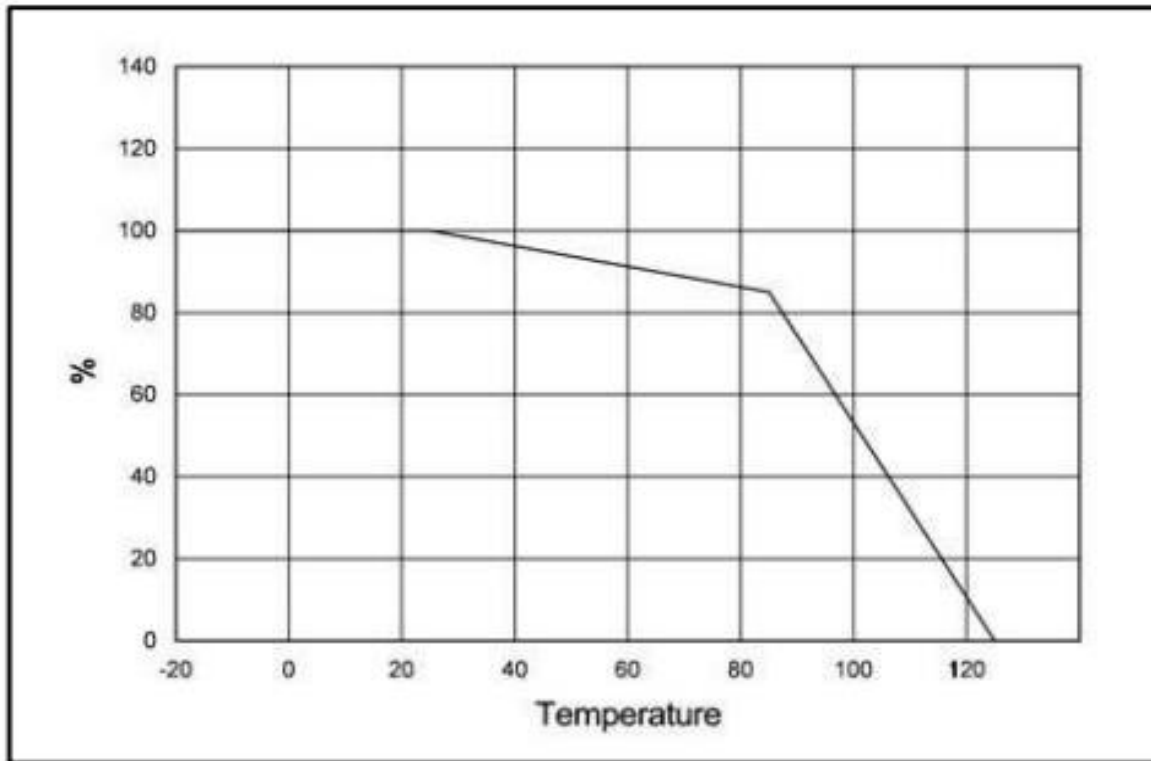

≠ Custom Assemblies

Passive Plus offers Capacitor Assemblies for high power requirements. Typical assemblies are configured in series and/or parallel combinations, producing higher voltage/current handling capabilities, extended capacitance range and tighter tolerances.

To get started, simply send us either a mechanical drawing or circuit conditions and we can recommend a solution. All components are 100% up-screened for Partial Discharge and Sonoscanned. All assemblies include a 100hr Military burn in.

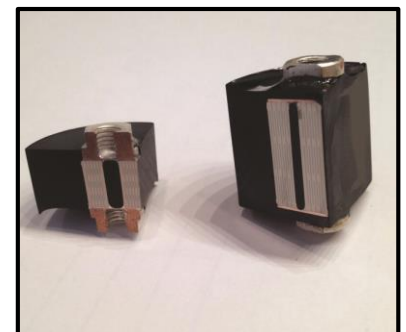

⚡ Recommended Land Pattern Dimensions

When mounting the capacitor to substrate, it's important to carefully consider that the amount of solder (size of fillet) used has a direct effect upon the capacitor once it's mounted.

- 1) The greater the amount of solder, the greater the stress to the elements. This may cause the substrate to break or crack.
- 2) In the situation where two or more devices are mounted onto a common land, be sure to separate the device into exclusive pads by using soldering resist.

⚡ Horizontal Mounting

A	B	C
16.00	3.30	19.60

Dimensions: mm

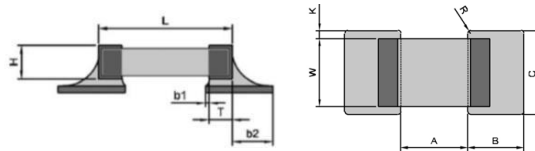



UHF/RF High Q Power Transmitter
Capacitors (NP0 TC)
Multi-Layer Ceramic Capacitors
Custom Capacitor Assemblies

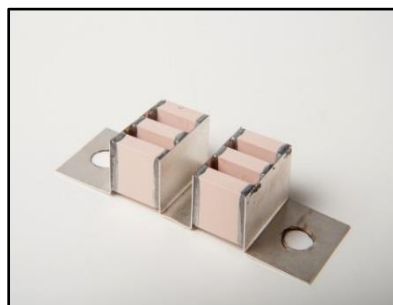
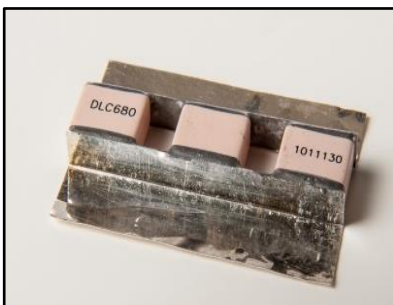
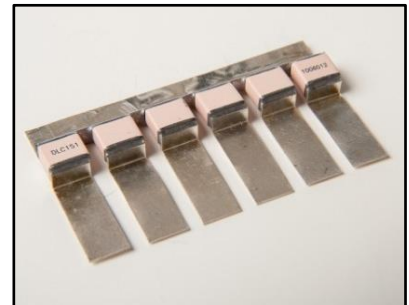
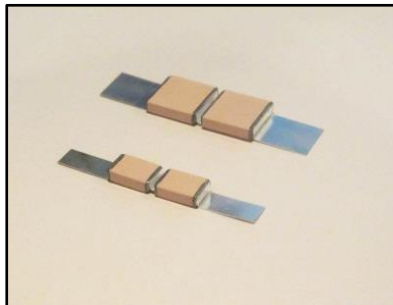

*Marking shown for illustration purposes only.
Actual marking may differ.*

Please contact PPI (sales@passiveplus.com) to discuss custom assembly options.



UHF/RF High Q Power Transmitter
Capacitors (NP0 TC)
Multi-Layer Ceramic Capacitors

Custom Capacitor Assemblies

≠ Product Features

High Operating Voltage, High Operating Current, Extended Capacitance, Tighter Tolerances, High Reliability, High Q, Ultra-low ESR, Non-Magnetic

≠ Typical Applications Field

High Power RF, Medical Electronics, Broadcast, Semiconductor Manufacturing, High Magnetic Environments, Inductive Heating



Marking shown for illustration purposes only. Actual marking may differ.

≠ Part Numbering

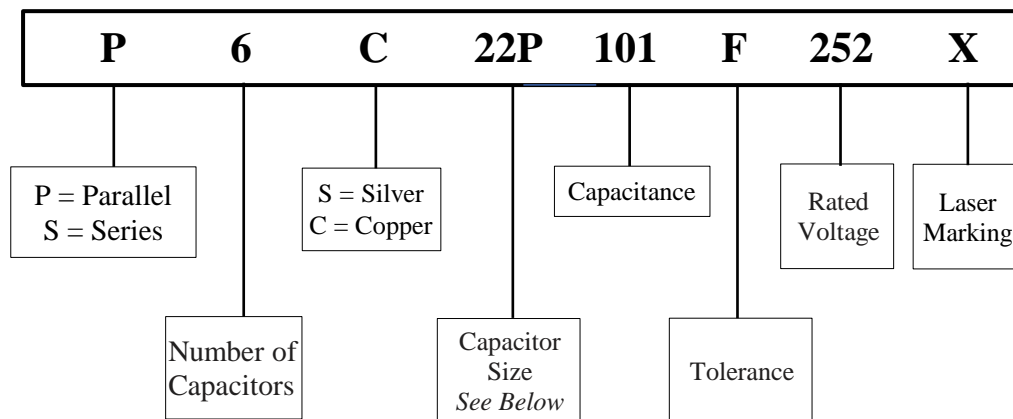

Capacitor Size:

11P = 1111; 22P = 2225; 38P = 3838; 60P = 6040; 76P = 7676

Capacitance: For capacitor values requiring 3 significant digits,

e.g. 1222.5pF = 1222R5

e.g. P6S22P101F252X

Silver bracket assembly with six 2225C pieces in parallel, Capacitance is 100pF, Capacitance tolerance is $\pm 1\%$, WVDC is 2500 V and Laser marking.

e.g. S2S25C1222R5G203X

Silver bracket assembly with two 2225C pieces in series, Capacitance is 1222.5pF,

Capacitance tolerance is $\pm 2\%$, WVDC is 20,000V and Laser marking.

≠ Capacitance and Voltage

By Buyer's requirements using existing drawings, mechanical sketches, or we can help with capable modeling of assemblies thermal rise predictions.



UHF/RF High Q Power Transmitter
Capacitors (NP0 TC)
Multi-Layer Ceramic Capacitors

Custom Capacitor Assemblies

≠ Typical Assembly Configurations

≠ Parallel Assemblies

unit:inch (millimeter)

	1111C/P	22225C/P	3838C/P	6040C	7676C
Lead Material	Silver plated Copper or Silver				
Lead Thickness	.004 or .010 (0.1 or 0.25)			.010 or .020 (0.25 or 0.51)	
Lead Length (max.)	.50 (12.7)	.75 (19.8)		2.0 (50.8)	
Capacitor Spacer (typ.)	.050 or .078 (1.3 or 2)			.090 (2.3)	.050 or .157 (1.3 or 4)
Mounting Configuration	Horizontal / Vertical				

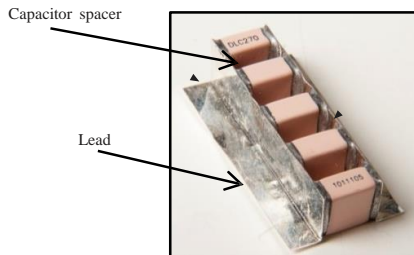

3838 Series/Parallel Combination

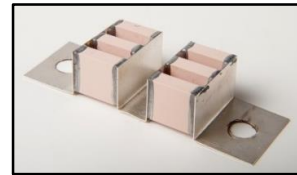

Marking shown for illustration purposes only. Actual marking may differ.

≠ Series Assemblies

unit:inch (millimeter)

	22225C/P	3838C/P	6040C	7676C
Lead Type	L Bracket			
Lead Material	Silver plated Copper or Silver			
Lead Thickness	.010 (0.25)		.010 or .020 (0.25 or 0.51)	
Lead Length (max.)	.75 (19.8)	1.0 (25.4)		
Capacitor Spacer (typ.)	.050 or .157 (1.3 or 4)			
Mounting Configuration	Horizontal			

- Epoxy Molding Available

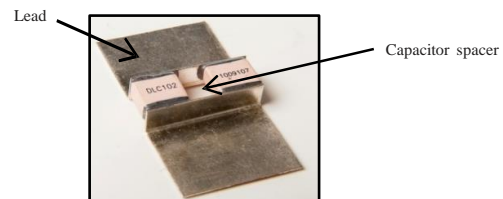

Other Assemblies: By Buyer's requirement. Contact PPI.

Marking shown for illustration purposes only. Actual marking may differ.



EIA Low ESR Microwave Capacitors

Product Features

- Lowest ESR
- Low Noise
- High Self-Resonance

Product Applications

Typical Functional Applications

- Tuning • Bypass • Coupling
- Feedback • D.C. Blocking
- Impedance Matching

Typical Circuit Applications

- UHF/Microwave RF Power Amplifiers
- Mixers • Oscillators • Filter Networks
- Low Noise Amplifiers • Timing Circuits and Delay Lines

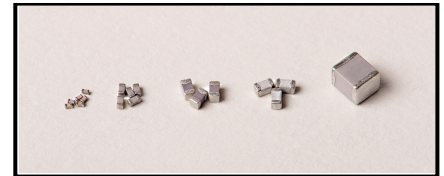

Part Numbering

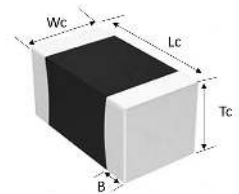
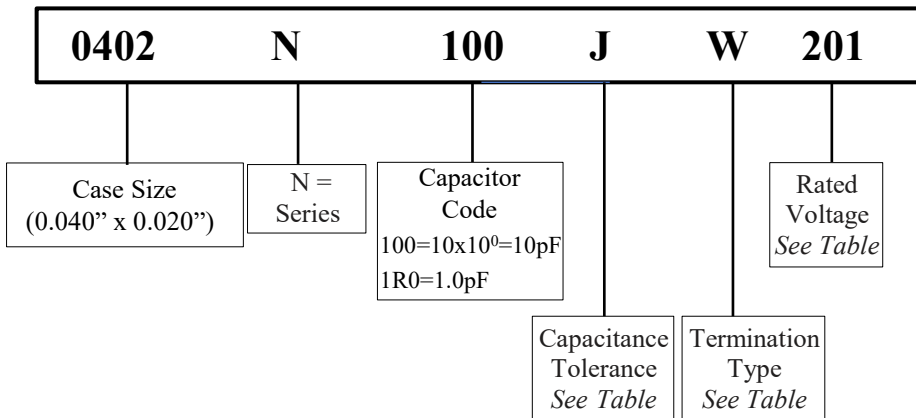

Case Size (Chip) Dimensions

	0201	0402	0603	0805	1111
Length (L_c)	0.024 ± 0.001 (0.60 ± 0.03)	0.040 ± 0.004 (1.02 ± 0.10)	0.062 ± 0.006 (1.57 ± 0.15)	0.080 ± 0.008 (2.03 ± 0.20)	0.110 + 0.020 to -0.010 (2.79 + 0.51 to -0.25)
Width (W_c)	0.012 ± 0.001 (0.30 ± 0.03)	0.020 ± 0.004 (0.51 ± 0.10)	0.032 ± 0.006 (0.81 ± 0.15)	0.050 ± 0.008 (1.27 ± 0.20)	0.110 ± 0.015 (2.79 ± 0.38)
Thickness (T_c)	0.012 ± 0.001 (0.30 ± 0.03)	0.020 ± 0.004 (0.51 ± 0.10)	0.030 ± 0.005-0.003 (0.76 ± 0.20-0.08)	0.040 ± 0.006 (1.02 ± 0.15)	0.10 (2.60) max
Overlap (B)	0.008 (0.20)	0.010 ± 0.006 (0.25 ± 0.15)	0.014 ± 0.006 (0.35 ± 0.15)	0.020 ± 0.010 (0.50 ± 0.25)	0.015 (0.024) max



EIA Low ESR Microwave Capacitors

± Temperature Coefficient

N: $0 \pm 30 \text{ ppm}/^\circ\text{C}$

± Rated Capacitance

Capacitance is less than 10pF; for example: 1R0=1.0pF, R denotes decimal point

Capacitance greater than 10pF; for example: 101=100pF, the third number is the power of 10

± Tolerance

Capacitance Tolerance								
Code	A	B	C	D	F	G	J	K
Tolerance	$\pm 0.05 \text{ pF}$	$\pm 0.1 \text{ pF}$	$\pm 0.25 \text{ pF}$	$\pm 0.5 \text{ pF}$	$\pm 1\%$	$\pm 2\%$	$\pm 5\%$	$\pm 10\%$

± Termination Types and Codes

Termination Code	Type	Magnetic Termination
W 	Chip	100% Sn Solder over Nickel Plating
L	Chip	90% Sn10%Pb Tin/Lead Solder over Nickel Plating

± Voltages

Code	Rated Voltage
250	25V
500	50V
251	250V
501	500V
102	1000V



EIA Low ESR Microwave Capacitors

≠ Laser Marking

An “X” at the end of the part number indicates the part is marked.

Laser Marking is available on the 0805N & 1111N case sizes.

≠ Packing Orientation Option

TV: Tape carrier packaging Vertical Orientation.

Vertical orientation means that if the part is lifted from the tape without any rotation and placed on a substrate, its electrodes will be perpendicular to the substrate plane. This impacts the frequency of First Parallel Resonance (suckout).

≠ Performance Requirements

Capacitors are designed and manufactured to meet the requirements of MIL-PRF-55681 and MIL-PRF-123.

All products are in compliance with RoHS instruction. 



≠ **Product Features**

- High Q
- High Power
- Low ESR/ESL
- Low Noise
- High Self-Resonance
- Ultra Stable Performance
- Capacitance Range:
0.1pF to 100pF
- Working Voltage: 50V

≠ **Product Applications**

Typical Functional Applications

- Tuning • Bypass • Coupling
- Feedback • D.C. Blocking
- Impedance Matching

Typical Circuit Applications

- UHF/Microwave RF Power Amplifiers
- Mixers • Oscillators • Filter Networks
- Low Noise Amplifiers • Timing Circuits and Delay Lines

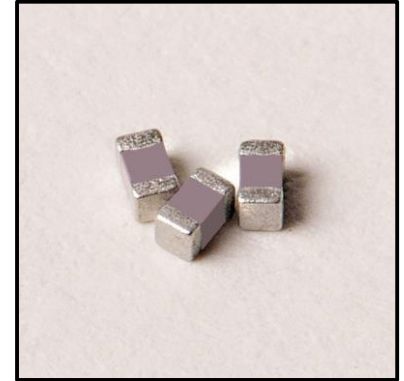

≠ **Part Numbering**

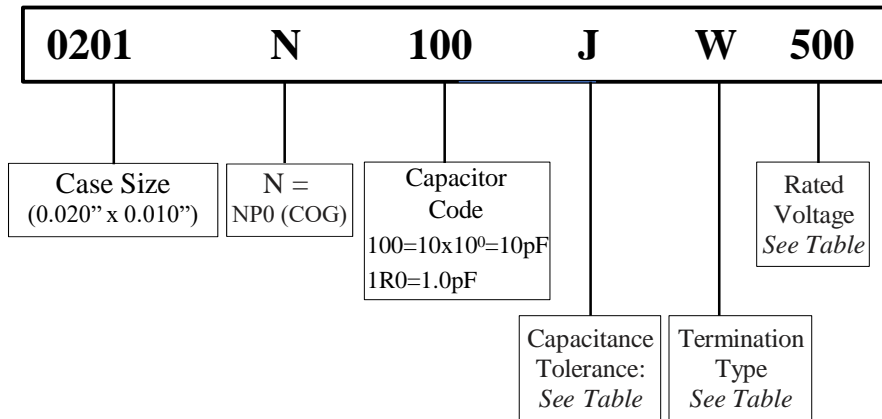

≠ **Capacitor Dimensions**

Unit: inch (millimeter)

Code	Term.	Length	Width	Thickness	Overlap
		Lc	Wc	Tc	B
W	Chip	0.024 ± 0.001 (0.60 ± 0.03)	0.012 ± 0.001 (0.30 ± 0.03)	0.012 ± 0.001 (0.30 ± 0.03)	0.008 (0.20)

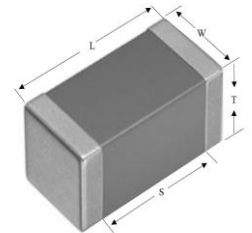

≠ **Capacitance Tolerance Codes**

Code	A	B	C	D	F	G	J	K
Tol.	±0.05pF	±0.1pF	±0.25pF	±0.5pF	±1%	±2%	±5%	±10%



EIA Low ESR
Multi-Layer Ceramic Capacitors

0201N (0.020" x 0.010")

≠ Terminations Type and Code

≠ Voltage Codes

Termination Code	Termination
W	100% Sn Solder over Nickel Plating

Voltage	Code
25V	250
50V	500



≠ 0201N Capacitance Values

For special capacitances, tolerances and WVDC, please contact PPI.

Cap. pF	Cap Code	Tol.	Rated WVDC		Cap. pF	Cap Code	Tol.	Rated WVDC		Cap. pF	Cap Code	Tol.	Rated WVD	
			Std.	Ext.				Std.	Ext.				Std.	Ext.
0.1	OR1	A,B, C,	25V	50V	2.2	2R2	A,B, C,	25V	50V	16	160	F,G, J,K	25V	50V
0.2	OR2				2.4	2R4				18	180			
0.3	OR3				2.7	2R7				20	200			
0.4	OR4				3.0	3R0				22	220			
0.5	OR5				3.3	3R3				24	240			
0.6	OR6				3.6	3R6				27	270			
0.7	OR7				3.9	3R9				30	300			
0.8	OR8				4.3	4R3				33	330			
0.9	OR9				4.7	4R7				36	360			
1.0	1R0				5.1	5R1				39	390			
1.1	1R1	B,C, D	25V	50V	5.6	5R6	25V	50V	43	430	F,G, J,K	25V	50V	
1.2	1R2				6.2	6R2			47	470				
1.3	1R3				6.8	6R8			51	510				
1.4	1R4				7.5	7R5			56	560				
1.5	1R5				8.2	8R2			62	620				
1.6	1R6				9.1	9R1			68	680				
1.7	1R7				10	100			75	750				
1.8	1R8				11	110			82	820				
1.9	1R9				12	120			91	910				
2.0	2R0				13	130			100	101				
2.1	2R1	15	150											



⚡ Electrical Specifications

Quality Factor (Q)	2,000 at 1 MHz
Insulation Resistance (IR)	10 ⁵ Megaohms min. @ +25°C rated WVDC 10 ⁴ Megaohms min. @ +125°C rated WVDC
Rated Voltage	25V or 50V
Dielectric Withstanding Voltage (WVDC)	250% of Rated Voltage of 5 seconds
Operating Temperature Range	-55°C to 175°C
Temperature Coefficient (TC)	0±30ppm/°C
Capacitance Drift	±0.02% or ±0.02pF, whichever is greater
Piezoelectric Effects	None

⚡ Environmental Specifications

	Specification	Test Parameters
Thermal Shock	No mechanical damage Capacitance Change: ±0.5% or 0.5pF max IR: >1 G Ohms Q>2000 Breakdown Voltage: 2.5x WVDC	MIL-STD-202, Method 107, Condition A. At the maximum rated temperature (-55°C and 175°C) stay 30 minutes, the time of removing shall not be more than 3 minutes. Perform five cycles.
Humidity (Steady State)	No mechanical damage Capacitance Change: ±0.5% or 0.5pF max IR: >1 G Ohms Q>300 Breakdown Voltage: 2.5x WVDC	MIL-STD-202, Method 106
Low Voltage Humidity	No mechanical damage Capacitance Change: ±0.3% or 0.3pF max IR: >1 G Ohms Q>300 Breakdown Voltage: 2.5x WVDC	MIL-STD-202, Method 103, Condition A, with 1.5 Volts DC applied while subjected to an environment of 85°C with 85% relative humidity for 240 hours minimum.
Life	No mechanical damage Capacitance Change: ±2.0% or 0.5pF max IR: >1 G Ohms Q>500 Breakdown Voltage: 2.5x WVDC	MIL-STD-202, Method 108. For 1000 hours, at 175°C. 200% of Voltage for Capacitors
Terminal Adhesion	Termination should not pull off. Ceramic should remain undamaged	Linear pull force exerted on axial leads soldered to each terminal 2.0lbs.
Resistance to Soldering Heat	No mechanical damage Capacitance Change: -1.0%~+2.0% IR: >10 G Ohms Q>500 Breakdown Voltage: 2.5x WVDC	Preheat device to 150°C -180°C for 60 seconds. Dip in 260°C ±5°C solder for 10 ±1 second. Measure after 24± 2 hour cooling period.

Capacitors are designed and manufactured to meet the requirements of MIL-PRF-55681 and MIL-PRF-123.

≡ ESR vs. Frequency



0201N Equivalent Series Resistances (ESRs)

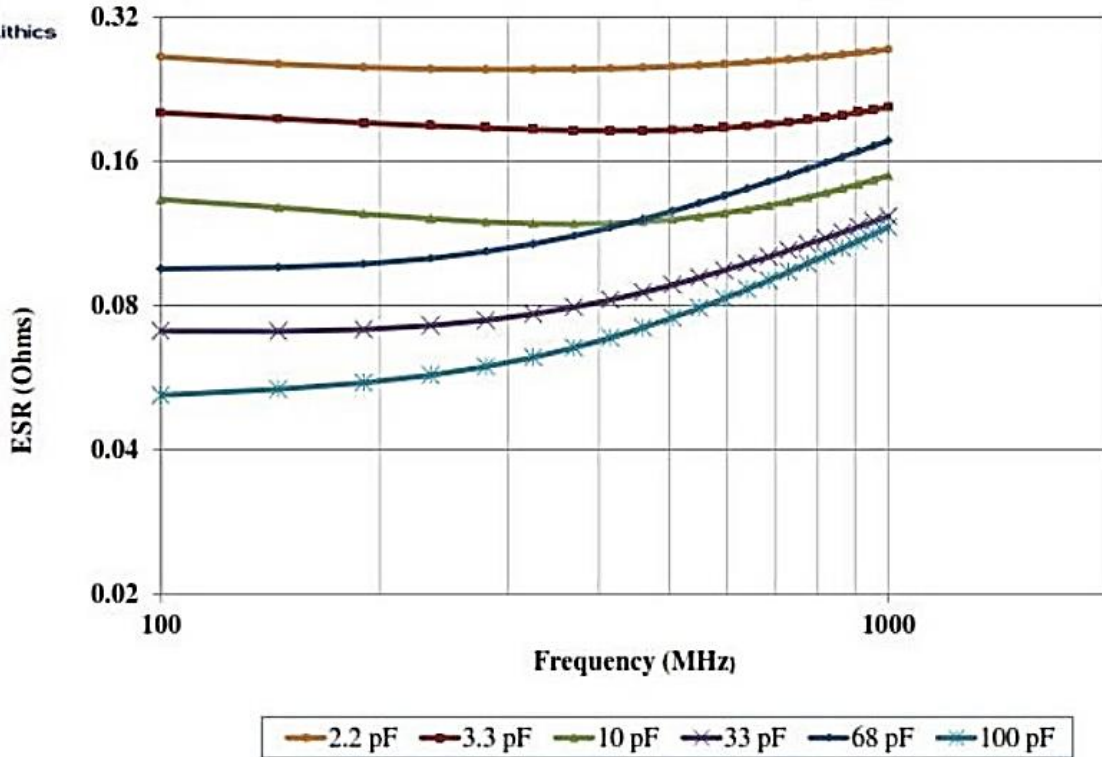

≠ First Parallel Resonance

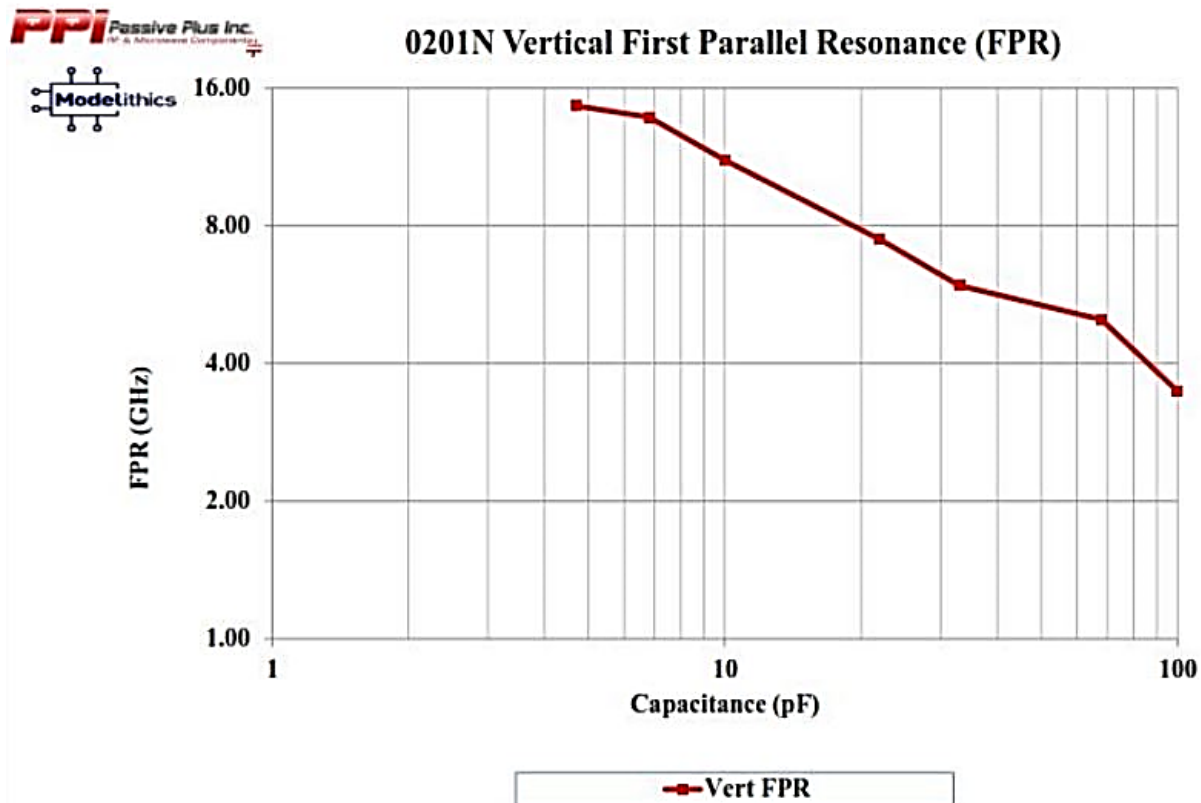

≠ Definitions and Measurement Conditions

The **First Parallel Resonance, FPR**, is defined as the lowest frequency at which a suckout or notch appears in $|S_{21}|$. It is generally independent of substrate thickness or dielectric constant, but does depend on capacitor orientation. A vertical orientation means the electrode planes are perpendicular to the substrate.

The definitions on the charts are for a capacitor in a series configuration, i.e., mounted across a gap in a microstrip trace with 50-Ohm termination. The measurement conditions are: substrate – Rogers RO3006; substrate dielectric constant = 6.15; substrate thickness (mils) = 10; gap in microstrip trace (mils) = 6.0; microstrip trace width (mils) = 14.1; Reference planes at sample edges.

All data has been derived from electrical models created by Modelithics, Inc., a specialty vendor contracted by PPI. The models are derived from measurements on a large number of parts disposed on several different substrates.

≡ First Series Resonance

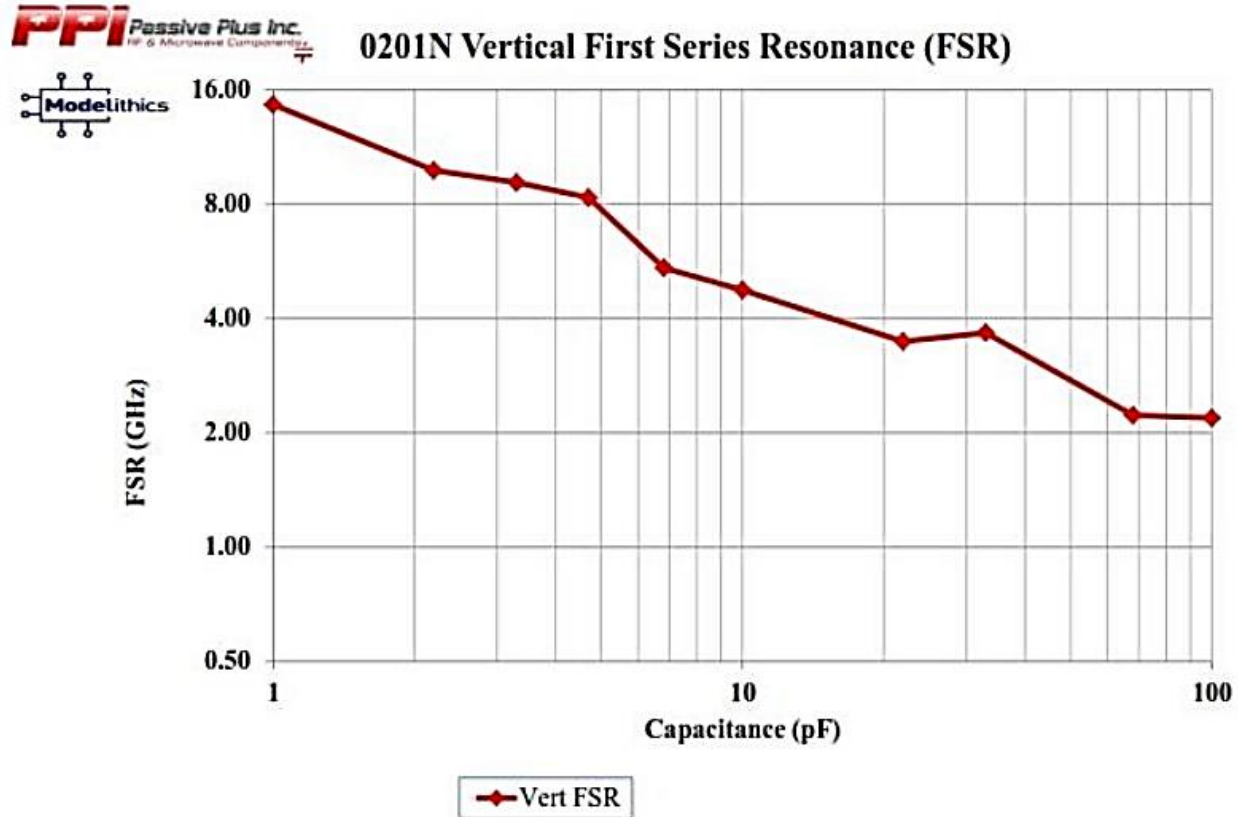

≡ Definitions and Measurement Conditions

The **First Series Resonance, FSR**, is defined as the lowest frequency at which the imaginary part of the input impedance, $\text{Im}[Z_{in}]$, equals zero. Should $\text{Im}[Z_{in}]$ or the real part of the input impedance, $\text{Re}[Z_{in}]$, not be monotonic with frequency at frequencies lower than those at which $\text{Im}[Z_{in}] = 0$, the FSR shall be considered as undefined (represented as a gap in the plot). FSR is dependent on internal capacitor structure; substrate thickness and dielectric constant; capacitor orientation, as defined alongside the FPR plot; and mounting pad dimensions.

The definitions on the charts are for a capacitor in a series configuration, i.e., mounted across a gap in a microstrip trace with 50-Ohm termination. The measurement conditions are: substrate – Rogers RO3006; substrate dielectric constant = 6.15; substrate thickness (mils) = 10; gap in microstrip trace (mils) = 6.0; microstrip trace width (mils) = 14.1; Reference planes at sample edges.

All data has been derived from electrical models created by Modelithics, Inc., a specialty vendor contracted by PPI. The models are derived from measurements on a large number of parts disposed on several different substrates.

≠ Capacitor Application Program

Passive Plus, Inc.'s brand new **online Capacitor Application Program (C.A.P.)** helps Engineers and Designers select capacitors according to parameters such as cap value and frequency. C.A.P. allows engineers to insert capacitors requirements (Cap value, Frequency), producing Scattering Matrices (S2P) Charts while providing options (Case Size, Terminations, Mounting), and parameters (ESR, Q, Impedance) along with Datasheets. Once engineers have determined their capacitor requirements, C.A.P. also includes online Requests For Quotes (RFQs) and/or sample requests.

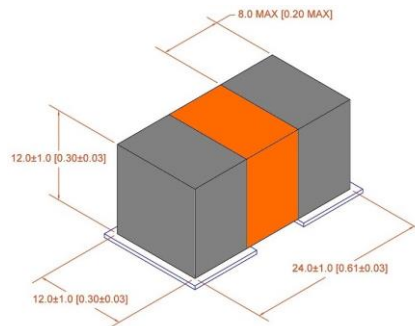

≠ Modelithics Vendor Program

PPI offers design engineers a Free 90-Day Trial license for the Modelithics PPI Component Library. This program provides engineers access to extremely accurate scalable simulation models for Passive Plus capacitors with advanced features that enable a more precise and rapid design process.

Microwave Global Models include every part value in a series and permit users to input substrate thickness, dielectric constant, and loss tangent, as well as mounting pad layout dimensions. Selected models also include capacitor orientation – vertical or horizontal – as an input. Engineers can request FREE use of the models, by either visiting the [Passive Plus Resources page \(http://passiveplus.com/addldocs_resources.php\)](http://passiveplus.com/addldocs_resources.php).



≠ Recommended Land Pattern Dimensions

When mounting the capacitor to substrate, it's important to carefully consider that the amount of solder (size of fillet) used has a direct effect upon the capacitor once it's mounted.



1) The greater the amount of solder, the greater the stress to the elements. This may cause the substrate to break or crack.

2) In the situation where two or more devices are mounted onto a common land, be sure to separate the device into exclusive pads by using soldering resist.

≠ Horizontal Mounting Dimensions: mm

A	B	C
0.28	0.28	0.37

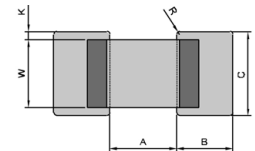
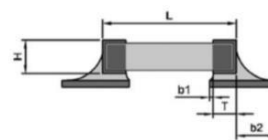

≠ Tape & Reel Specifications Dimensions: mm

Horizontal Orientation

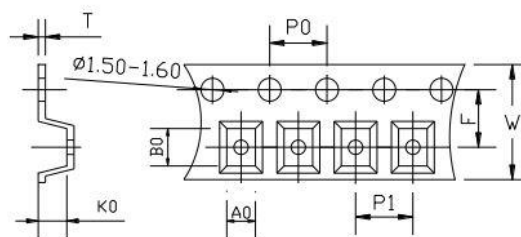

Dimensions: mm

Orientation	A0	B0	K0	W	P0	P1	T	F	Qty Min	Qty/reel	Tape Material
Horizontal	0.406	0.749	0.422	8.00	4.00	2.00	0.42	3.50	500	500	Paper



EIA Low ESR
Multi-Layer Ceramic Capacitors



0201N (0.020" x 0.010")

≠ Engineering Design Kits

PPI offers Design Kits for engineers who are building and testing prototypes. Each kit contains 16 values; 10 pieces per value.

Kits are 100% RoHS compliant.



Kit Number	Value Range	Values	
DKD0201N01	0.1 - 2.0pF	0.1, 0.2, 0.3, 0.5, 0.7, 0.8, 0.9, 1.0, 1.3, 1.5, 1.7, 1.9, 2.0pF	
DKD0201N02	1.0 - 10pF	1.0, 1.3, 1.5, 1.7, 1.9, 2.0, 2.2, 2.7, 3.0, 3.9, 4.7, 5.6, 6.8, 7.5, 8.2, 10pF	
DKD0201N03	10 - 100pF	10, 13, 15, 18, 20, 22, 27, 30, 39, 47, 56, 68, 75, 82, 91, 100pF	



DKD0201N01

Passive Plus Inc.
RF & Microwave Components

0201N Series 0.1 — 2.0pF

Size: 0.020" x 0.010"
TC = NP0 WVDC = 50V

Hi-Q Low ESR Capacitor Design Kit



www.passiveplus.com



DKD0201N02

Passive Plus Inc.
RF & Microwave Components

0201N Series 1.0 — 10pF

Size: 0.020" x 0.010"
TC = NP0 WVDC = 50V

Hi-Q Low ESR Capacitor Design Kit



www.passiveplus.com



DKD0201N03

Passive Plus Inc.
RF & Microwave Components

0201N Series 10 — 100pF

Size: 0.020" x 0.010"
TC = NP0 WVDC = 50V

Hi-Q Low ESR Capacitor Design Kit



www.passiveplus.com



EIA Low ESR
Multi-Layer Ceramic Capacitors

0402N (0.040" x 0.020")

≠ **Product Features**

- High Q
- High Power
- Low ESR/ESL
- Low Noise
- High Self-Resonance
- Ultra Stable Performance
- Capacitance Range:
0.1pF to 33pF
- Working Voltage: 200V

≠ **Product Applications**

Typical Functional Applications

- Tuning • Bypass • Coupling
- Feedback • D.C. Blocking
- Impedance Matching

Typical Circuit Applications

- UHF/Microwave RF Power Amplifiers
- Mixers • Oscillators • Filter Networks
- Low Noise Amplifiers • Timing Circuits and Delay Lines

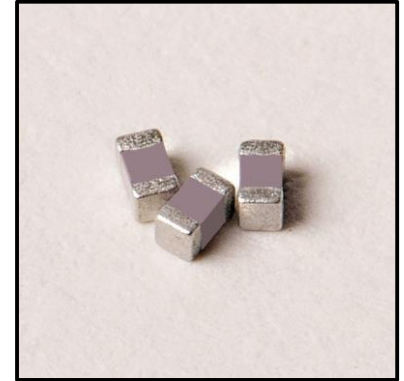

≠ **Part Numbering**

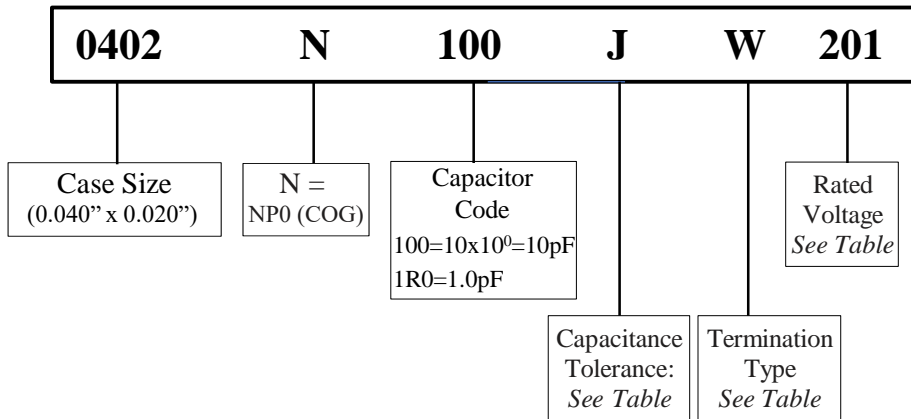

≠ **Capacitor Dimensions**

Unit: inch (millimeter)

Code	Term.	Length Lc	Width Wc	Thickness Tc	Overlap B
W	Chip	0.040 ± 0.004 (1.02 ± 0.10)	0.020 ± 0.004 (0.51 ± 0.10)	0.020 ± 0.004 (0.51 ± 0.10)	0.010 ± 0.006 (0.25 ± 0.15)

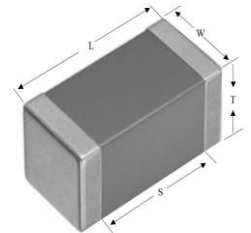

≠ **Capacitance Tolerance Codes**

Code	A	B	C	D	F	G	J	K
Tol.	±0.05pF	±0.1pF	±0.25pF	±0.5pF	±1%	±2%	±5%	±10%



EIA Low ESR
Multi-Layer Ceramic Capacitors

0402N (0.040" x 0.020")

≠ Terminations Type and Code

Termination Code	Termination
W	100% Sn Solder over Nickel Plating

≠ Voltage Codes

Voltage	Code
50V	500
200V	201
250V	251



≠ 0402N Capacitance Values

For special capacitances, tolerances and WVDC, please contact PPI.

Cap. pF	Cap Code	Tol.	Rated WVDC		Cap. pF	Cap Code	Tol.	Rated WVDC		Cap. pF	Cap Code	Tol.	Rated WVDC	
			Std.	Ext.				Std.	Ext.				Std.	Ext.
0.1	OR1	A,B, C,D	50V or 200V	250V	1.7	1R7	A,B, C,D	50V or 200V	250V	6.8	6R8	A,B, C	50V or 200V	N/A
0.2	OR2				1.8	1R8				7.5	7R5			
0.3	OR3				1.9	1R9				8.2	8R2			
0.4	OR4				2.0	2R0	50V or 200V	250V	9.1	9R1				
0.5	OR5				2.1	2R1			10	100				
0.6	OR6				2.2	2R2			11	110				
0.7	OR7				2.4	2R4			12	120				
0.8	OR8				2.7	2R7			13	130				
0.9	OR9				3.0	3R0			15	150				
1.0	1R0				3.3	3R3	16	160	F,G, J,K	50V or 200V	N/A			
1.1	1R1				3.6	3R6	18	180						
1.2	1R2				3.9	3R9	20	200						
1.3	1R3				4.3	4R3	22	220						
1.4	1R4				4.7	4R7	A,B, C,D	50V or 200V	N/A	24	240			
1.5	1R5				5.1	5R1				27	270			
1.6	1R6				5.6	5R6				30	300	F,G, J,K	50V	N/A
		6.2	6R2	33	330									



⚡ Electrical Specifications

Quality Factor (Q)	2,000 at 1 MHz
Insulation Resistance (IR)	10 ⁵ Megaohms min. @ +25°C rated WVDC 10 ⁴ Megaohms min. @ +125°C rated WVDC
Rated Voltage	See Rated Voltage
Dielectric Withstanding Voltage (WVDC)	250% of Rated Voltage of 5 seconds
Operating Temperature Range	-55°C to 175°C
Temperature Coefficient (TC)	0±30ppm/°C
Capacitance Drift	±0.02% or ±0.02pF, whichever is greater
Piezoelectric Effects	None

⚡ Environmental Specifications

	Specification	Test Parameters
Thermal Shock	No mechanical damage Capacitance Change: ±0.5% or 0.5pF max IR: >1 G Ohms Q>2000 Breakdown Voltage: 2.5x WVDC	MIL-STD-202, Method 107, Condition A. At the maximum rated temperature (-55°C and 175°C) stay 30 minutes, the time of removing shall not be more than 3 minutes. Perform five cycles.
Humidity (Steady State)	No mechanical damage Capacitance Change: ±0.5% or 0.5pF max IR: >1 G Ohms Q>300 Breakdown Voltage: 2.5x WVDC	MIL-STD-202, Method 106
Low Voltage Humidity	No mechanical damage Capacitance Change: ±0.3% or 0.3pF max IR: >1 G Ohms Q>300 Breakdown Voltage: 2.5x WVDC	MIL-STD-202, Method 103, Condition A, with 1.5 Volts DC applied while subjected to an environment of 85°C with 85% relative humidity for 240 hours minimum.
Life	No mechanical damage Capacitance Change: ±2.0% or 0.5pF max IR: >1 G Ohms Q>500 Breakdown Voltage: 2.5x WVDC	MIL-STD-202, Method 108. For 1000 hours, at 175°C. 200% of Voltage for Capacitors
Terminal Adhesion	Termination should not pull off. Ceramic should remain undamaged	Linear pull force exerted on axial leads soldered to each terminal 2.0lbs.
Resistance to Soldering Heat	No mechanical damage Capacitance Change: -1.0%~+2.0% IR: >10 G Ohms Q>500 Breakdown Voltage: 2.5x WVDC	Preheat device to 150°C -180°C for 60 seconds. Dip in 260°C ±5°C solder for 10 ±1 second. Measure after 24± 2 hour cooling period.

Capacitors are designed and manufactured to meet the requirements of MIL-PRF-55681 and MIL-PRF-123.

≡ ESR vs. Frequency



0402N Equivalent Series Resistances (ESRs)

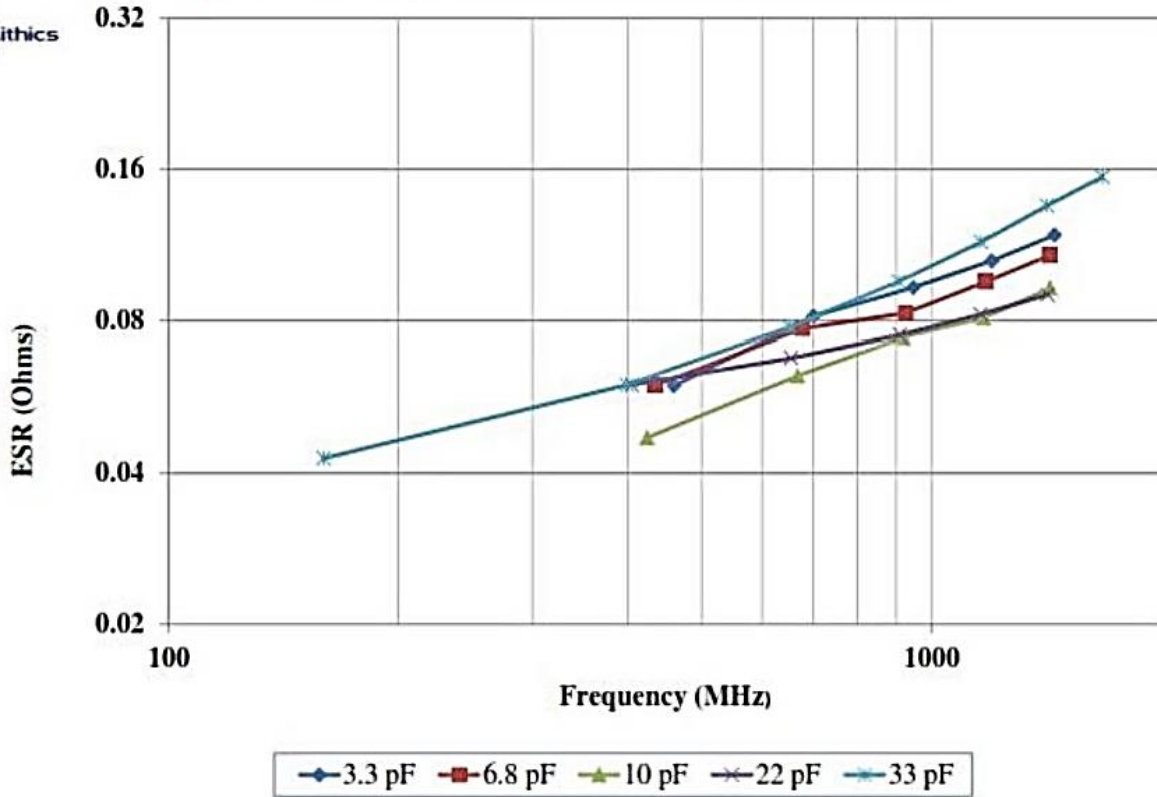

≠ First Parallel Resonance



0402N Horizontal First Parallel Resonance (FPR)

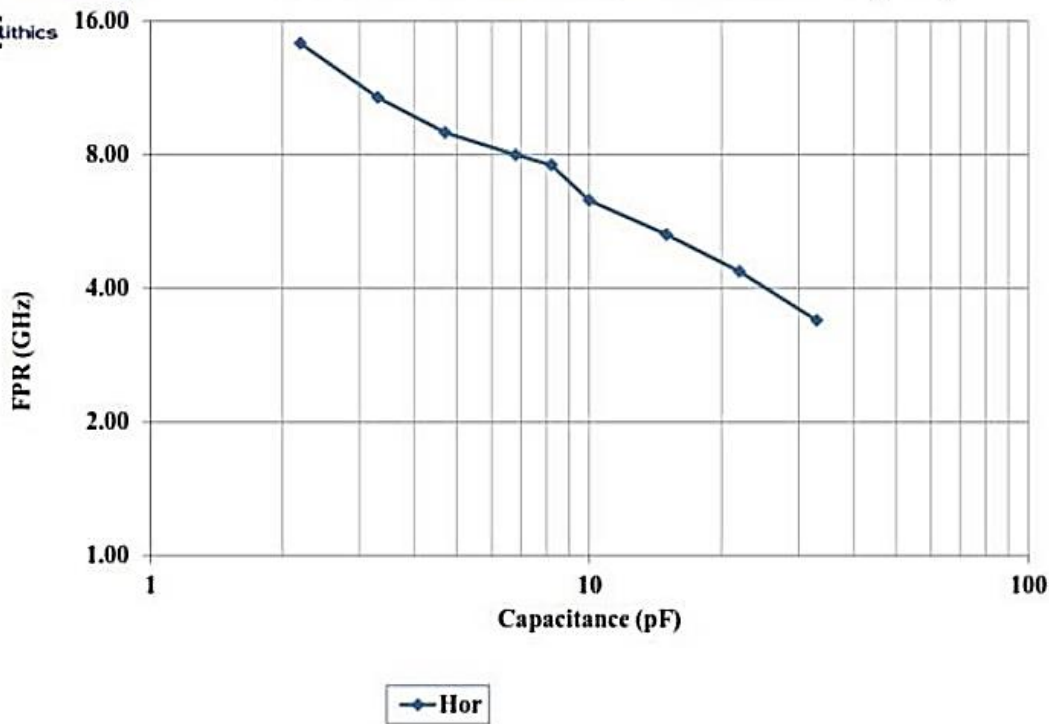

≠ Definitions and Measurement Conditions

The **First Parallel Resonance, FPR**, is defined as the lowest frequency at which a suckout or notch appears in $|S_{21}|$. It is generally independent of substrate thickness or dielectric constant, but does depend on capacitor orientation. A vertical orientation means the electrode planes are perpendicular to the substrate.

The definitions on the charts are for a capacitor in a series configuration, i.e., mounted across a gap in a microstrip trace with 50-Ohm termination. The measurement conditions are: substrate – Rogers RO4350; substrate dielectric constant = 3.48; substrate thickness (mils) = 10; gap in microstrip trace (mils) = 15; microstrip trace width (mils) = 22; Reference planes at sample edges.

All data has been derived from electrical models created by Modelithics, Inc., a specialty vendor contracted by PPI. The models are derived from measurements on a large number of parts disposed on several different substrates.

≠ First Series Resonance

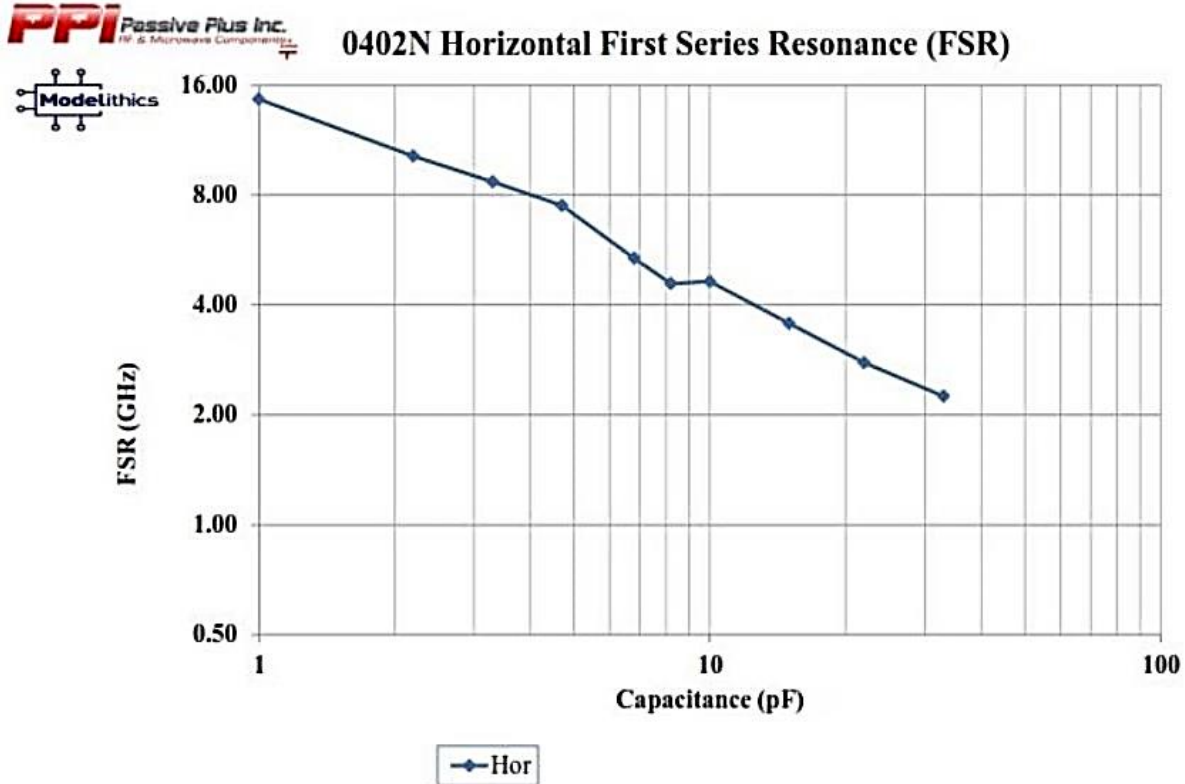

≠ Definitions and Measurement Conditions

The **First Series Resonance, FSR**, is defined as the lowest frequency at which the imaginary part of the input impedance, $\text{Im}[Z_{in}]$, equals zero. Should $\text{Im}[Z_{in}]$ or the real part of the input impedance, $\text{Re}[Z_{in}]$, not be monotonic with frequency at frequencies lower than those at which $\text{Im}[Z_{in}] = 0$, the FSR shall be considered as undefined (represented as a gap in the plot). FSR is dependent on internal capacitor structure; substrate thickness and dielectric constant; capacitor orientation, as defined alongside the FPR plot; and mounting pad dimensions.

The definitions on the charts are for a capacitor in a series configuration, i.e., mounted across a gap in a microstrip trace with 50-Ohm termination. The measurement conditions are: substrate – Rogers RO4350; substrate dielectric constant = 3.48; substrate thickness (mils) = 10; gap in microstrip trace (mils) = 15; microstrip trace width (mils) = 22; Reference planes at sample edges.

All data has been derived from electrical models created by Modelithics, Inc., a specialty vendor contracted by PPI. The models are derived from measurements on a large number of parts disposed on several different substrates.

≠ Capacitor Application Program

Passive Plus, Inc.'s brand new **online Capacitor Application Program (C.A.P.)** helps Engineers and Designers select capacitors according to parameters such as cap value and frequency. C.A.P. allows engineers to insert capacitors requirements (Cap value, Frequency), producing Scattering Matrices (S2P) Charts while providing options (Case Size, Terminations, Mounting), and parameters (ESR, Q, Impedance) along with Datasheets. Once engineers have determined their capacitor requirements, C.A.P. also includes online Requests For Quotes (RFQs) and/or sample requests.

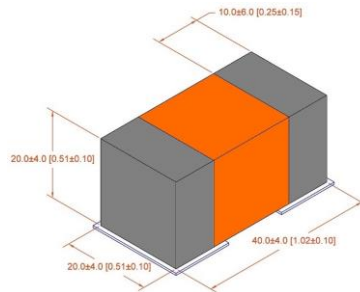

≠ Modelithics Vendor Program

PPI offers design engineers a Free 90-Day Trial license for the Modelithics PPI Component Library. This program provides engineers access to extremely accurate scalable simulation models for Passive Plus capacitors with advanced features that enable a more precise and rapid design process.

Microwave Global Models include every part value in a series and permit users to input substrate thickness, dielectric constant, and loss tangent, as well as mounting pad layout dimensions. Selected models also include capacitor orientation – vertical or horizontal – as an input. Engineers can request FREE use of the models, by either visiting the [Passive Plus Resources page \(http://passiveplus.com/addldocs_resources.php\)](http://passiveplus.com/addldocs_resources.php).



≠ Recommended Land Pattern Dimensions

When mounting the capacitor to substrate, it's important to carefully consider that the amount of solder (size of fillet) used has a direct effect upon the capacitor once it's mounted.



1) The greater the amount of solder, the greater the stress to the elements. This may cause the substrate to break or crack.

2) In the situation where two or more devices are mounted onto a common land, be sure to separate the device into exclusive pads by using soldering resist.

≠ Horizontal Mounting Dimensions: mm

A	B	C
0.41	0.41	0.54

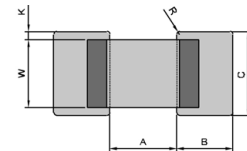
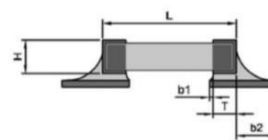

≠ Tape & Reel Specifications Dimensions: mm

Horizontal Orientation

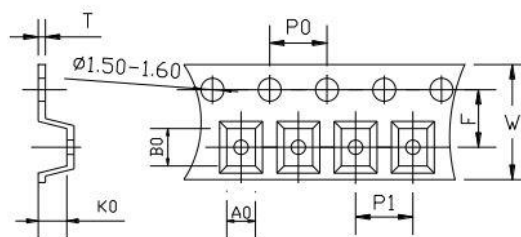

Orientation	A0	B0	K0	W	P0	P1	T	F	Qty Min	Qty/reel	Tape Material
Horizontal	0.60	1.10	1.00	8.00	4.00	2.00	0.20	3.50	500	500	Paper



EIA Low ESR
Multi-Layer Ceramic Capacitors

0402N (0.040" x 0.020")

≠ Engineering Design Kits

PPI offers Design Kits for engineers who are building and testing prototypes. Each kit contains 16 values; 10 pieces per value.

Kits are 100% RoHS compliant.



Kit Number	Value Range	Values	
DKD0402N01	0.1 - 2.0pF	0.1, 0.2, 0.3, 0.4, 0.5, 0.6, 0.7, 0.8, 0.9, 1.0, 1.2, 1.5, 1.6, 1.8, 2.0pF	
DKD0402N02	1.0 - 10pF	1.0, 1.2, 1.5, 1.8, 2.0, 2.2, 2.4, 2.7, 3.0, 3.3, 3.9, 4.7, 5.6, 6.8, 8.2, 10pF	
DKD0402N03	10 - 33pF	10, 12, 13, 15, 16, 18, 20, 22, 24, 27, 30, 33pF	

PPI
Passive Plus Inc.
RF & Microwave Components

DKD0402N01

0402N Series 0.1 — 2.0pF

Size: 0.040" x 0.020"
TC = NP0 WVDC = 200V

Hi-Q Low ESR Capacitor Design Kit

www.passiveplus.com

PPI
Passive Plus Inc.
RF & Microwave Components

DKD0402N02

0402N Series 1.0 — 10pF

Size: 0.040" x 0.020"
TC = NP0 WVDC = 200V

Hi-Q Low ESR Capacitor Design Kit

www.passiveplus.com

PPI
Passive Plus Inc.
RF & Microwave Components

DKD0402N03

0402N Series 10 — 33pF

Size: 0.040" x 0.020"
TC = NP0 WVDC = 200V

Hi-Q Low ESR Capacitor Design Kit

www.passiveplus.com



≠ Product Features

- High Q
- High Power
- Low ESR/ESL
- Low Noise
- High Self-Resonance
- Ultra Stable Performance
- Capacitance Range:
0.1pF to 100pF
- Working Voltage: 250V

≠ Product Applications

Typical Functional Applications

- Tuning • Bypass • Coupling
- Feedback • D.C. Blocking
- Impedance Matching

Typical Circuit Applications

- UHF/Microwave RF Power Amplifiers
- Mixers • Oscillators • Filter Networks
- Low Noise Amplifiers • Timing Circuits and Delay Lines

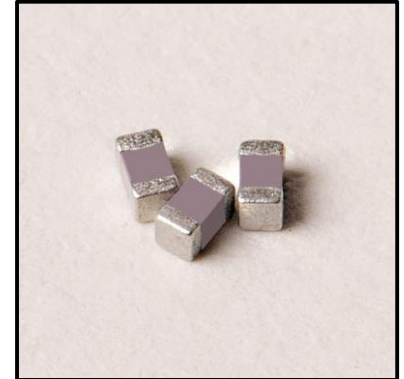

≠ Part Numbering

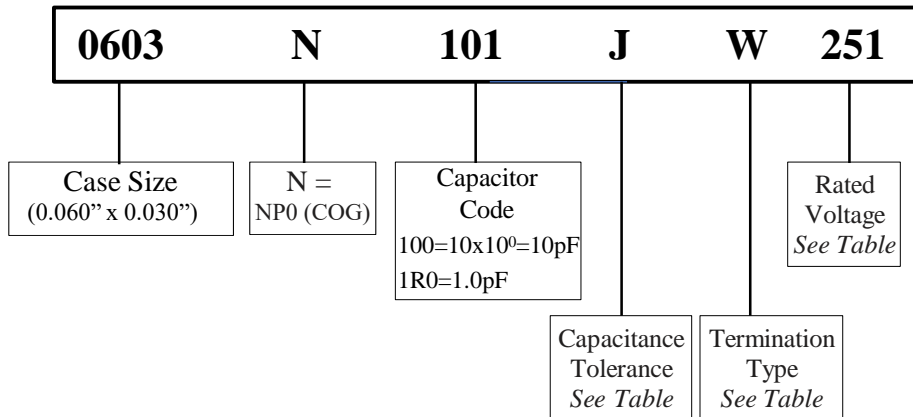

≠ Capacitor Dimensions

Unit: inch (millimeter)

Code	Term.	Length	Width	Thickness	Overlap
		Lc	Wc	Tc	B
W	Chip	0.062 ± 0.006 (1.57 ± 0.15)	0.032 ± 0.006 (0.81 ± 0.15)	0.030 ± 0.005-0.003 (0.76 ± 0.20-0.08)	0.014 ± 0.006 (0.35 ± 0.15)

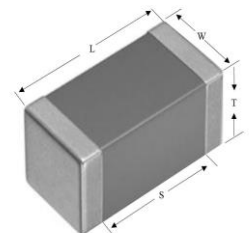

≠ Capacitance Tolerance Codes

Code	A	B	C	D	F	G	J	K
Tol.	±0.05pF	±0.1pF	±0.25pF	±0.5pF	±1%	±2%	±5%	±10%



EIA Low ESR
Multi-Layer Ceramic Capacitors

0603N (0.060" x 0.030")

≠ Terminations Types and Codes

Termination Code	Termination
W	100% Sn Solder over Nickel Plating
L	90%Sn10%Pb Tin/Lead

≠ Voltage Code

Voltage	Code
250V	251



≠ 0603N Capacitance Values

For special capacitances, tolerances and WVDC, please contact PPI.

Cap. pF	Cap Code	Tol.	Rated WVDC	Cap. pF	Cap Code	Tol.	Rated WVDC	Cap. pF	Cap Code	Tol.	Rated WVDC	Cap. pF	Cap Code	Tol.	Rated WVDC
0.1	OR1			1.7	1R7			6.2	6R2			30	300		
0.2	OR2			1.8	1R8			6.8	6R8			33	330		
0.3	OR3			1.9	1R9			7.5	7R5	A,B,C	250V	36	360		
0.4	OR4			2.0	2R0			8.2	8R2			39	390		
0.5	OR5			2.1	2R1			9.1	9R1			43	430		
0.6	OR6			2.2	2R2			10	100			47	470		
0.7	OR7			2.4	2R4			11	110			51	510	F,G,J,K	250V
0.8	OR8	A,B,C,D	250V	2.7	2R7	A,B,C,D	250V	12	120			56	560		
0.9	OR9			3.0	3R0			13	130			62	620		
1.0	1R0			3.3	3R3			15	150	F,G,J,K	250V	68	680		
1.1	1R1			3.6	3R6			16	160			75	750		
1.2	1R2			3.9	3R9			18	180			82	820		
1.3	1R3			4.3	4R3			20	200			91	910		
1.4	1R4			4.7	4R7			22	220			100	101		
1.5	1R5			5.1	5R1			24	240						
1.6	1R6			5.6	5R6			27	270						



⚡ Electrical Specifications

Quality Factor (Q)	2,000 at 1 MHz
Insulation Resistance (IR)	10 ⁵ Megaohms min. @ +25°C rated WVDC 10 ⁴ Megaohms min. @ +125°C rated WVDC
Rated Voltage	250V
Dielectric Withstanding Voltage (WVDC)	250% of Rated Voltage of 5 seconds
Operating Temperature Range	-55°C to 175°C
Temperature Coefficient (TC)	0±30ppm/°C
Capacitance Drift	±0.02% or ±0.02pF, whichever is greater
Piezoelectric Effects	None

⚡ Environmental Specifications

	Specification	Test Parameters
Thermal Shock	No mechanical damage Capacitance Change: ±0.5% or 0.5pF max IR: >1 G Ohms Q>2000 Breakdown Voltage: 2.5x WVDC	MIL-STD-202, Method 107, Condition A. At the maximum rated temperature (-55°C and 175°C) stay 30 minutes, the time of removing shall not be more than 3 minutes. Perform five cycles.
Humidity (Steady State)	No mechanical damage Capacitance Change: ±0.5% or 0.5pF max IR: >1 G Ohms Q>300 Breakdown Voltage: 2.5x WVDC	MIL-STD-202, Method 106
Low Voltage Humidity	No mechanical damage Capacitance Change: ±0.3% or 0.3pF max IR: >1 G Ohms Q>300 Breakdown Voltage: 2.5x WVDC	MIL-STD-202, Method 103, Condition A, with 1.5 Volts DC applied while subjected to an environment of 85°C with 85% relative humidity for 240 hours minimum.
Life	No mechanical damage Capacitance Change: ±2.0% or 0.5pF max IR: >1 G Ohms Q>500 Breakdown Voltage: 2.5x WVDC	MIL-STD-202, Method 108. For 1000 hours, at 175°C. 200% of Voltage for Capacitors
Terminal Adhesion	Termination should not pull off. Ceramic should remain undamaged	Linear pull force exerted on axial leads soldered to each terminal 2.0lbs.
Resistance to Soldering Heat	No mechanical damage Capacitance Change: -1.0%~+2.0% IR: >10 G Ohms Q>500 Breakdown Voltage: 2.5x WVDC	Preheat device to 150°C -180°C for 60 seconds. Dip in 260°C ±5°C solder for 10 ±1 second. Measure after 24± 2 hour cooling period.

Capacitors are designed and manufactured to meet the requirements of MIL-PRF-55681 and MIL-PRF-123.



≠ ESR vs. Frequency

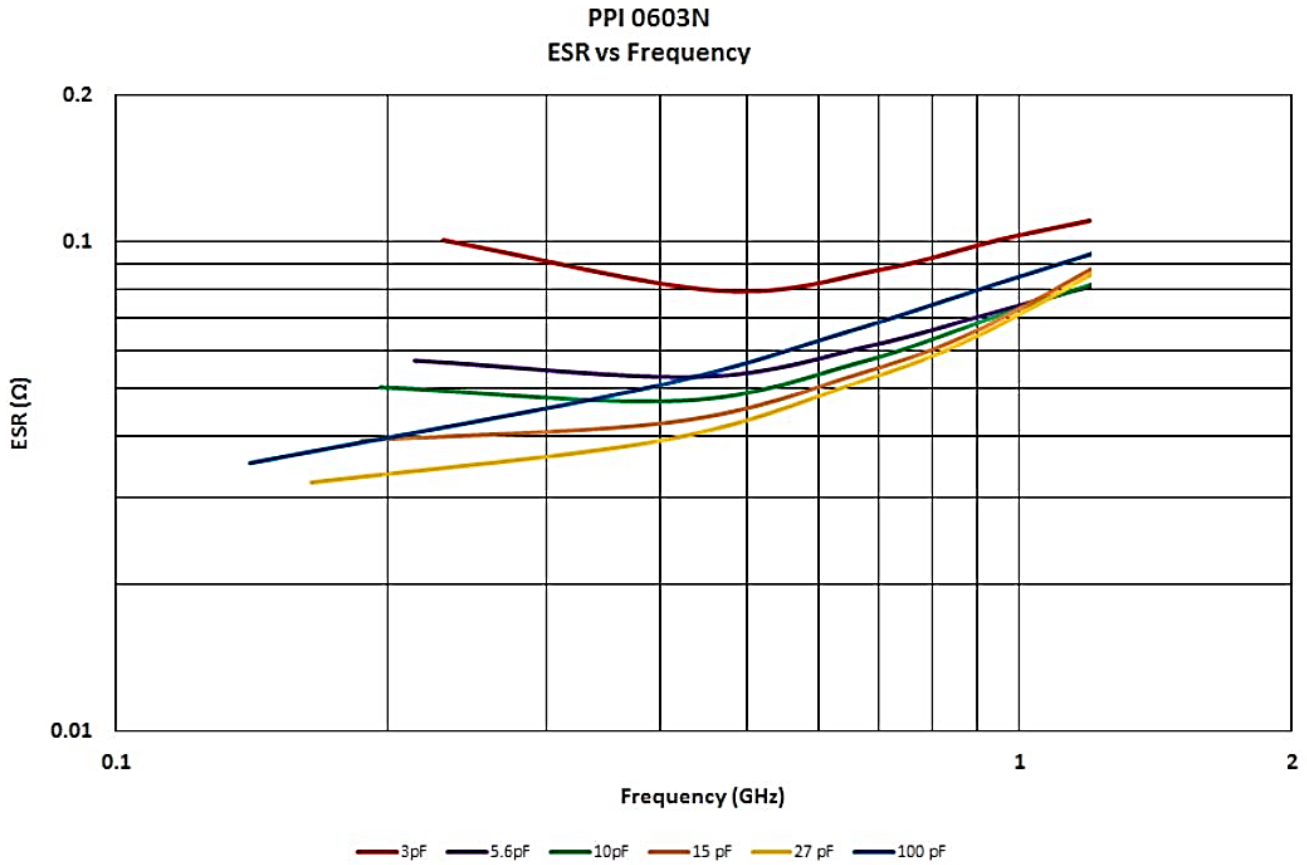

≠ First Parallel Resonance

0603N Horizontal First Parallel Resonances (FPR)

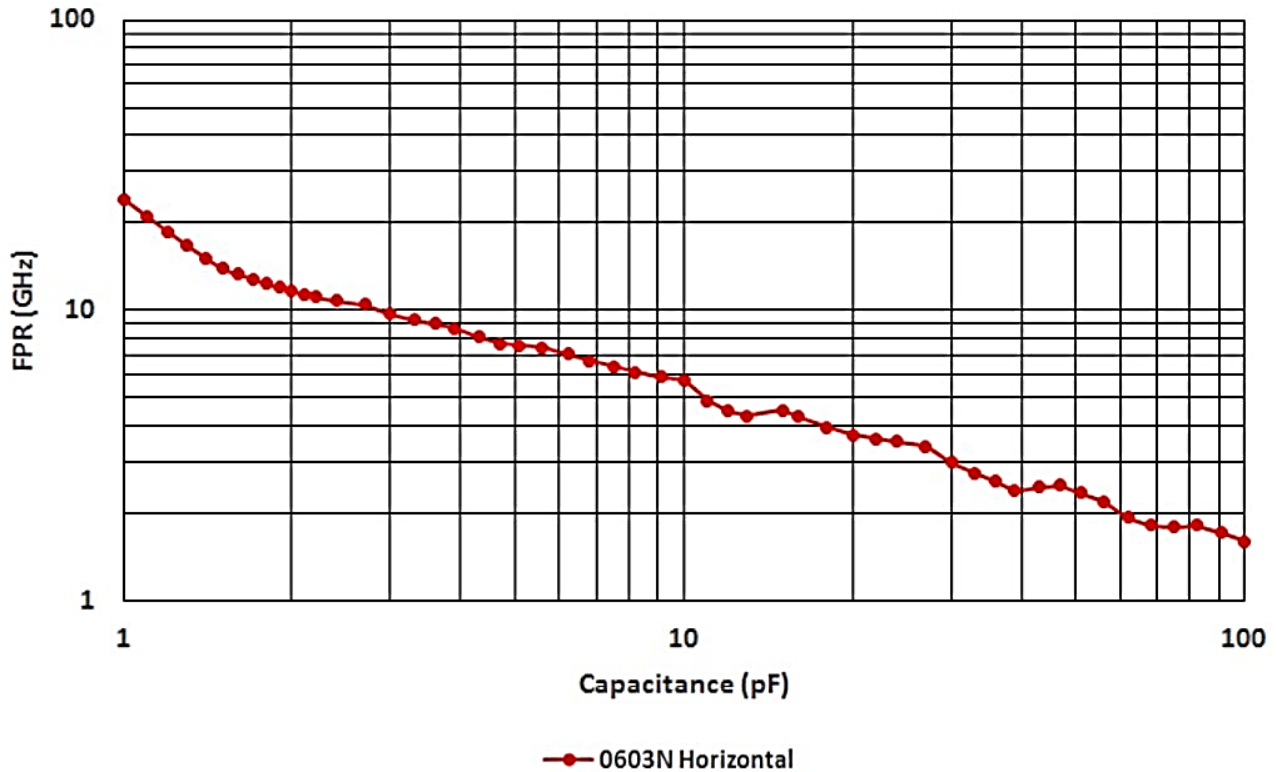

≠ Definitions and Measurement Conditions

The **First Parallel Resonance, FPR**, is defined as the lowest frequency at which a suckout or notch appears in $|S_{21}|$. It is generally independent of substrate thickness or dielectric constant, but does depend on capacitor orientation. A vertical orientation means the electrode planes are perpendicular to the substrate.

The definitions on the charts are for a capacitor in a series configuration, i.e., mounted across a gap in a microstrip trace with 50-Ohm termination. The measurement conditions are: substrate – Rogers RT/duriod® 5880; substrate dielectric constant = 2.20; substrate thickness (mils) = 10; gap in microstrip trace (mils) = 23.7; microstrip trace width (mils) = 30.0; Reference planes at sample edges.

All data has been derived from electrical models created by Modelithics, Inc., a specialty vendor contracted by PPI. The models are derived from measurements on a large number of parts disposed on several different substrates.

≠ First Series Resonance

0603N Horizontal First Series Resonances (FSR)

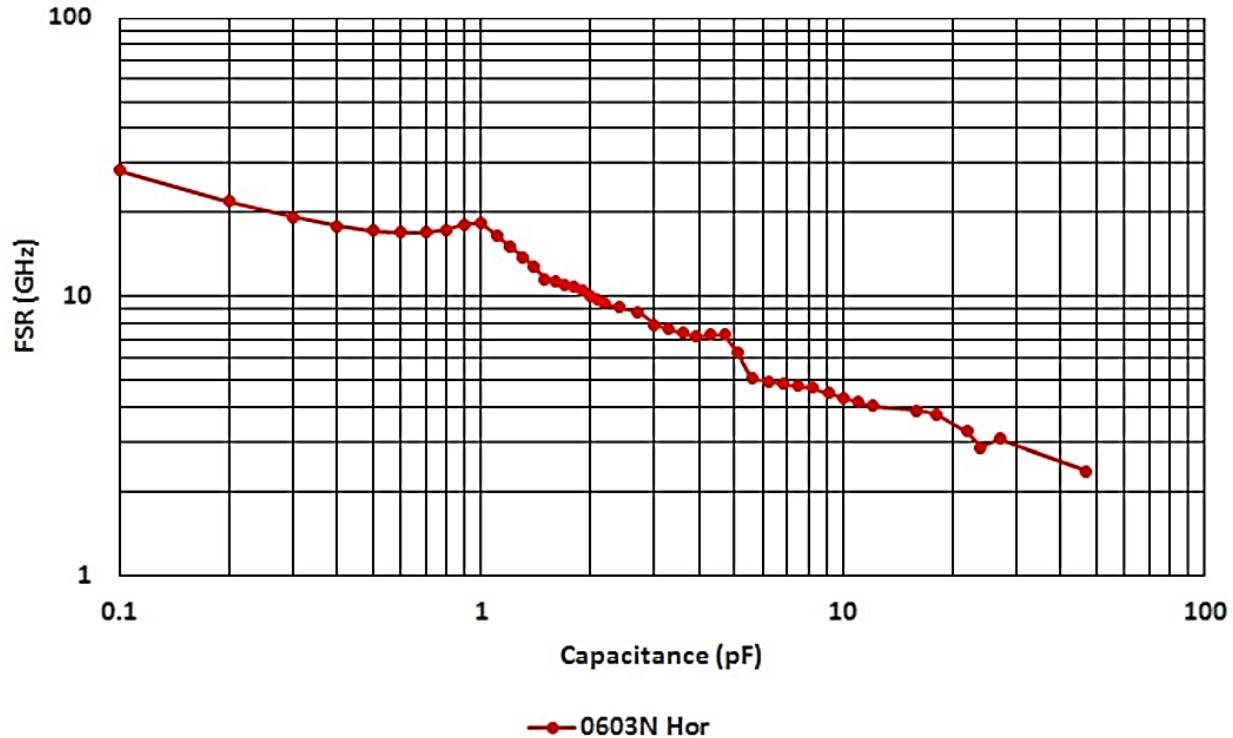

≠ Definitions and Measurement Conditions

The **First Series Resonance, FSR**, is defined as the lowest frequency at which the imaginary part of the input impedance, $\text{Im}[Z_{in}]$, equals zero. Should $\text{Im}[Z_{in}]$ or the real part of the input impedance, $\text{Re}[Z_{in}]$, not be monotonic with frequency at frequencies lower than those at which $\text{Im}[Z_{in}] = 0$, the FSR shall be considered as undefined (represented as a gap in the plot). FSR is dependent on internal capacitor structure; substrate thickness and dielectric constant; capacitor orientation, as defined alongside the FPR plot; and mounting pad dimensions.

The definitions on the charts are for a capacitor in a series configuration, i.e., mounted across a gap in a microstrip trace with 50-Ohm termination. The measurement conditions are: substrate – Rogers RT/duriod® 5880; substrate dielectric constant = 2.20; substrate thickness (mils) = 10; gap in microstrip trace (mils) = 23.7; microstrip trace width (mils) = 30.0; Reference planes at sample edges.

All data has been derived from electrical models created by Modelithics, Inc., a specialty vendor contracted by PPI. The models are derived from measurements on a large number of parts disposed on several different substrates.

⚡ Capacitor Application Program

Passive Plus, Inc.'s brand new **online Capacitor Application Program (C.A.P.)** helps Engineers and Designers select capacitors according to parameters such as cap value and frequency. C.A.P. allows engineers to insert capacitors requirements (Cap value, Frequency), producing Scattering Matrices (S2P) Charts while providing options (Case Size, Terminations, Mounting), and parameters (ESR, Q, Impedance) along with Datasheets. Once engineers have determined their capacitor requirements, C.A.P. also includes online Requests For Quotes (RFQs) and/or sample requests.

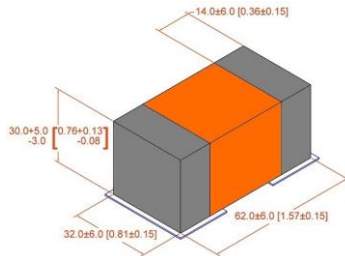

⚡ Modelithics Vendor Program

PPI offers design engineers a Free 90-Day Trial license for the Modelithics PPI Component Library. This program provides engineers access to extremely accurate scalable simulation models for Passive Plus capacitors with advanced features that enable a more precise and rapid design process.

Microwave Global Models include every part value in a series and permit users to input substrate thickness, dielectric constant, and loss tangent, as well as mounting pad layout dimensions. Selected models also include capacitor orientation – vertical or horizontal – as an input. Engineers can request FREE use of the models, by either visiting the [Passive Plus Resources page](http://passiveplus.com/addldocs_resources.php) (http://passiveplus.com/addldocs_resources.php).



≠ Recommended Land Pattern Dimensions

When mounting the capacitor to substrate, it's important to carefully consider that the amount of solder (size of fillet) used has a direct effect upon the capacitor once it's mounted.



1) The greater the amount of solder, the greater the stress to the elements. This may cause the substrate to break or crack.

2) In the situation where two or more devices are mounted onto a common land, be sure to separate the device into exclusive pads by using soldering resist.

≠ Horizontal Mounting

A	B	C
0.70	0.90	0.90

Dimensions: mm

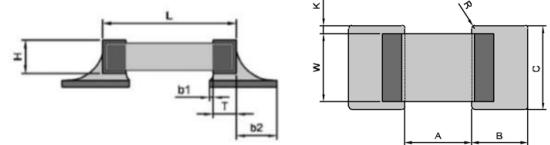

≠ Tape & Reel Specifications Dimensions: mm

Horizontal Orientation

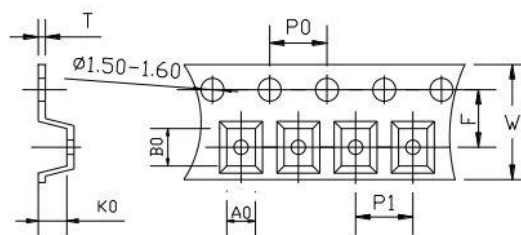

Orientation	A0	B0	K0	W	P0	P1	T	F	Qty Min	Qty/reel	Tape Material
Horizontal	0.95	1.80	0.85	8.00	4.00	4.00	0.20	3.50	500	500	Paper

Dimensions: mm



EIA Low ESR
Multi-Layer Ceramic Capacitors

0603N (0.060" x 0.030")

≠ Engineering Design Kits

PPI offers Design Kits for engineers who are building and testing prototypes. Each kit contains 16 values; 10 pieces per value.

Kits are 100% RoHS compliant.



Kit Number	Value Range	Values	
DKD0603N01	0.1 - 2.0pF	0.1, 0.2, 0.3, 0.4, 0.5, 0.6, 0.7, 0.8, 0.9, 1.0, 1.1, 1.2, 1.5, 1.6, 1.8, 2.0pF	
DKD0603N02	1.0 - 10pF	1.0, 1.2, 1.5, 1.8, 2.0, 2.2, 2.4, 2.7, 3.0, 3.3, 3.9, 4.7, 5.6, 6.8, 8.2, 10pF	
DKD0603N03	10 - 100pF	10, 12, 15, 18, 20, 22, 24, 27, 30, 33, 39, 47, 56, 68, 100pF	

PPI
Passive Plus Inc.
RF & Microwave Components

DKD0603N01

0603N Series 0.1 — 2.0pF
Size: 0.060" x 0.030"
TC = NP0 WVDC = 250V

Hi-Q Low ESR Capacitor Design Kit

www.passiveplus.com

PPI
Passive Plus Inc.
RF & Microwave Components

DKD0603N02

0603N Series 1.0 — 10pF
Size: 0.060" x 0.030"
TC = NP0 WVDC = 250V

Hi-Q Low ESR Capacitor Design Kit

www.passiveplus.com

PPI
Passive Plus Inc.
RF & Microwave Components

DKD0603N03

0603N Series 10 — 100pF
Size: 0.060" x 0.030"
TC = NP0 WVDC = 250V

Hi-Q Low ESR Capacitor Design Kit

www.passiveplus.com



EIA Low ESR
Multi-Layer Ceramic Capacitors

0805N (0.080" x 0.050")

≠ Product Features

- High Q
- High Power
- Low ESR/ESL
- Low Noise
- High Self-Resonance
- Ultra Stable Performance
- Capacitance Range:
0.1pF to 220pF

≠ Product Applications

Typical Functional Applications

- Tuning • Bypass • Coupling
- Feedback • D.C. Blocking
- Impedance Matching

Typical Circuit Applications

- UHF/Microwave RF Power Amplifiers
- Mixers • Oscillators • Filter Networks
- Low Noise Amplifiers • Timing Circuits and Delay Lines



Marking shown for illustration purposes only. Actual marking may differ.

≠ Part Numbering

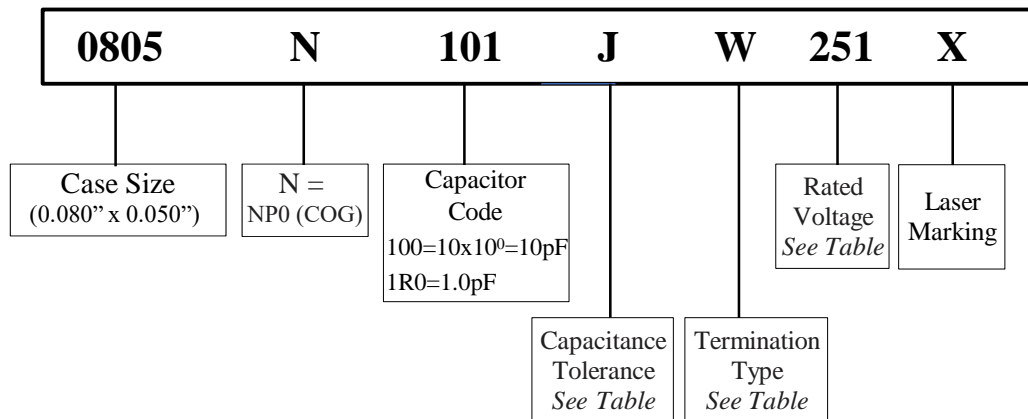

≠ Capacitor Dimensions Unit: inch (millimeter)

Code	Term.	Length	Width	Thickness	Overlap
		Lc	Wc	Tc	B
W	Chip	0.080 ± 0.008 (2.03±0.20)	0.050 ± 0.008 (1.27 ±0.20)	0.040±0.006 (1.02±0.15)	0.020±0.010 (0.50±0.25)

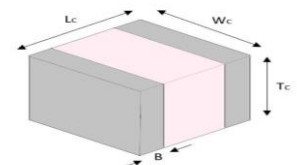

≠ Capacitance Tolerance Codes

Code	A	B	C	D	F	G	J	K
Tol.	±0.05pF	±0.1pF	±0.25pF	±0.5pF	±1%	±2%	±5%	±10%



EIA Low ESR
Multi-Layer Ceramic Capacitors

0805N (0.080" x 0.050")

≠ Terminations Types and Codes

Termination Code	Termination
W 	100% Sn Solder over Nickel Plating
L	90%Sn10%Pb Tin/Lead

≠ Voltage Code

Voltage	Code
250V	251



≠ 0805N Capacitance Values

For special capacitances, tolerances and WVDC, please contact PPI.

Cap. pF	Cap Code	Tol.	Rated WVDC	Cap. pF	Cap Code	Tol.	Rated WVDC	Cap. pF	Cap Code	Tol.	Rated WVDC	Cap. pF	Cap Code	Tol.	Rated WVDC
0.1	OR1			2.1	2R1			13	130			91	910		
0.2	OR2			2.2	2R2			15	150			100	101		
0.3	OR3			2.4	2R4			16	160			110	111		
0.4	OR4			2.7	2R7			18	180			120	121		
0.5	OR5			3.0	3R0			20	200			130	131		
0.6	OR6			3.3	3R3			22	220			150	151		
0.7	OR7			3.6	3R6	A,B, C,D	250V	24	240			160	161		
0.8	OR8			3.9	3R9			27	270			180	181		
0.9	OR9			4.3	4R3			30	300			200	201		
1.0	1R0	A,B, C,D	250V	4.7	4R7			33	330	F,G, J,K	250V	220	221		
1.1	1R1			5.1	5R1			36	360						
1.2	1R2			5.6	5R6			39	390						
1.3	1R3			6.2	6R2			43	430						
1.4	1R4			6.8	6R8			47	470						
1.5	1R5			7.5	7R5	B,C	250V	51	510						
1.6	1R6			8.2	8R2			56	560						
1.7	1R7			9.1	9R1			62	620						
1.8	1R8			10	100			68	680						
1.9	1R9			11	110	F,G, J,K	250V	75	750						
2.0	2R0			12	120			82	820						



⚡ Electrical Specifications

Quality Factor (Q)	2,000 at 1 MHz
Insulation Resistance (IR)	10 ⁵ Megaohms min. @ +25°C rated WVDC 10 ⁴ Megaohms min. @ +125°C rated WVDC
Rated Voltage	250V
Dielectric Withstanding Voltage (WVDC)	250% of Rated Voltage of 5 seconds
Operating Temperature Range	-55°C to 175°C
Temperature Coefficient (TC)	0±30ppm/°C
Capacitance Drift	±0.02% or ±0.02pF, whichever is greater
Piezoelectric Effects	None

⚡ Environmental Specifications

	Specification	Test Parameters
Thermal Shock	No mechanical damage Capacitance Change: ±0.5% or 0.5pF max IR: >10 G Ohms Q>2000 Breakdown Voltage: 2.5x WVDC	MIL-STD-202, Method 107, Condition A. At the maximum rated temperature (-55°C and 175°C) stay 30 minutes, the time of removing shall not be more than 3 minutes. Perform five cycles.
Humidity (Steady State)	No mechanical damage Capacitance Change: ±0.5% or 0.5pF max IR: >1 G Ohms Q>300 Breakdown Voltage: 2.5x WVDC	MIL-STD-202, Method 106
Life	No mechanical damage Capacitance Change: ±2.0% or 0.5pF max IR: >1 G Ohms Q>500 Breakdown Voltage: 2.5x WVDC	MIL-STD-202, Method 108. For 1000 hours, at 175°C. 200% of Voltage for Capacitors, Rated Voltage ≤ 500VDC; 120% of Voltage for Capacitors, 500VDC < Rated Voltage ≤ 1250VDC; 100% for Voltage for Capacitors, Rated Voltage > 1250VDC
Terminal Adhesion	Termination should not pull off. Ceramic should remain undamaged	Linear pull force exerted on axial leads soldered to each terminal. 2.0lbs.
Resistance to Soldering Heat	No mechanical damage Capacitance Change: -1.0%~+2.0% IR: >10 G Ohms Q>500 Breakdown Voltage: 2.5x WVDC	Preheat device to 150°C -180°C for 60 seconds. Dip in 260°C ±5°C solder for 10 ±1 second. Measure after 24± 2 hour cooling period.

Capacitors are designed and manufactured to meet the requirements of MIL-PRF-55681 and MIL-PRF-123.



EIA Low ESR
Multi-Layer Ceramic Capacitors
0805N (0.080" x 0.050")

≠ ESR vs. Frequency 3.9pF to 100pF

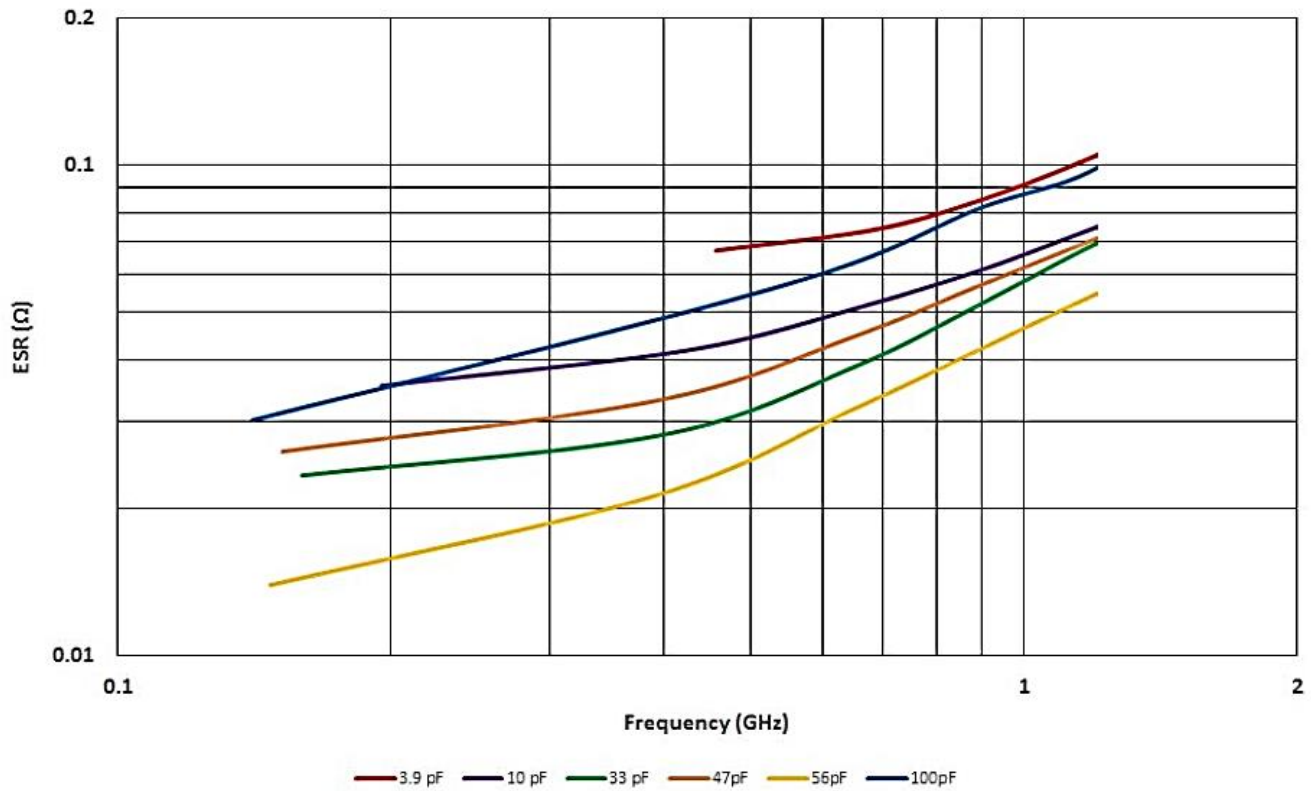

≠ First Parallel Resonance

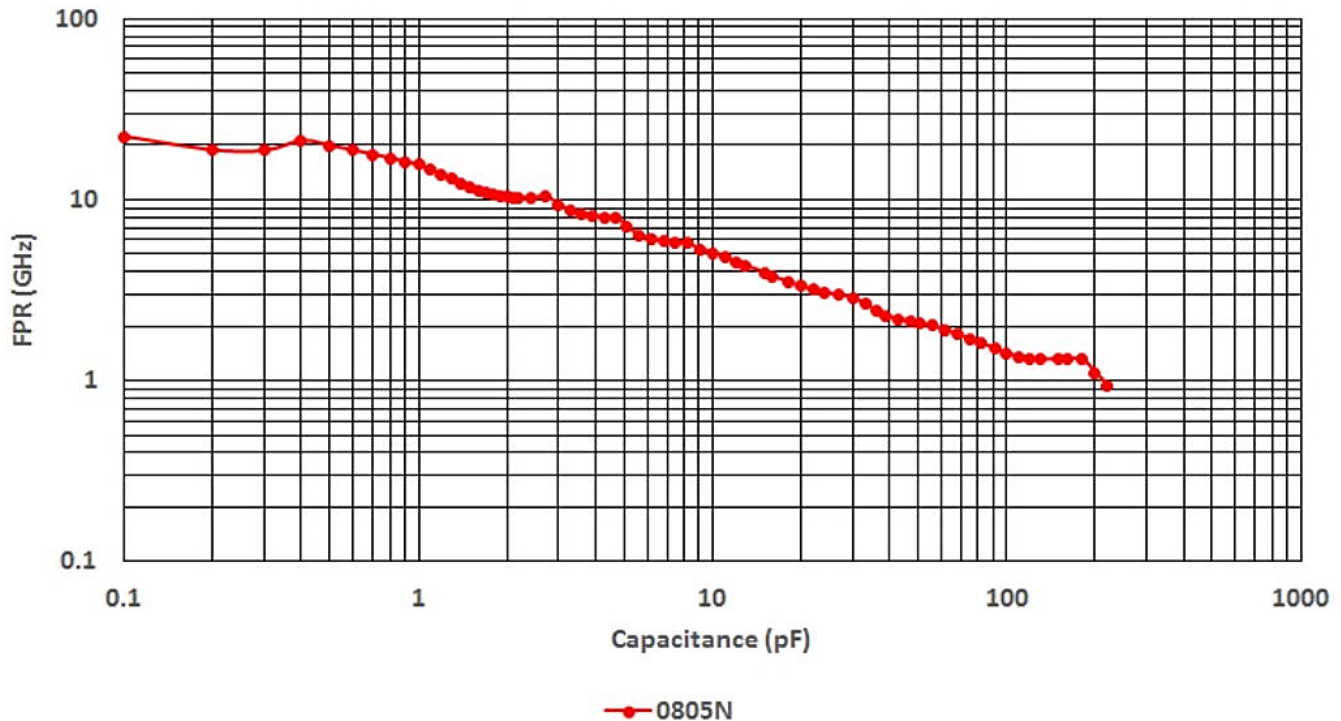

≠ Definitions and Measurement Conditions

The **First Parallel Resonance, FPR**, is defined as the lowest frequency at which a suckout or notch appears in $|S_{21}|$. It is generally independent of substrate thickness or dielectric constant, but does depend on capacitor orientation. A horizontal orientation means the capacitor electrode planes are parallel to the plane of the substrate; a vertical orientation means the electrode planes are perpendicular to the substrate.

The definitions on the charts are for a capacitor in a series configuration, i.e., mounted across a gap in a microstrip trace with 50-Ohm termination. The measurement conditions are: substrate – Rogers RO3003; substrate dielectric constant = 3.00; substrate thickness (mils) = 23; gap in microstrip trace (mils) = 23.6; microstrip trace width (mils) = 57.1; Reference planes at sample edges.

All data has been derived from electrical models created by Modelithics, Inc., a specialty vendor contracted by PPI. The models are derived from measurements on a large number of parts disposed on several different substrates.

≠ First Series Resonance

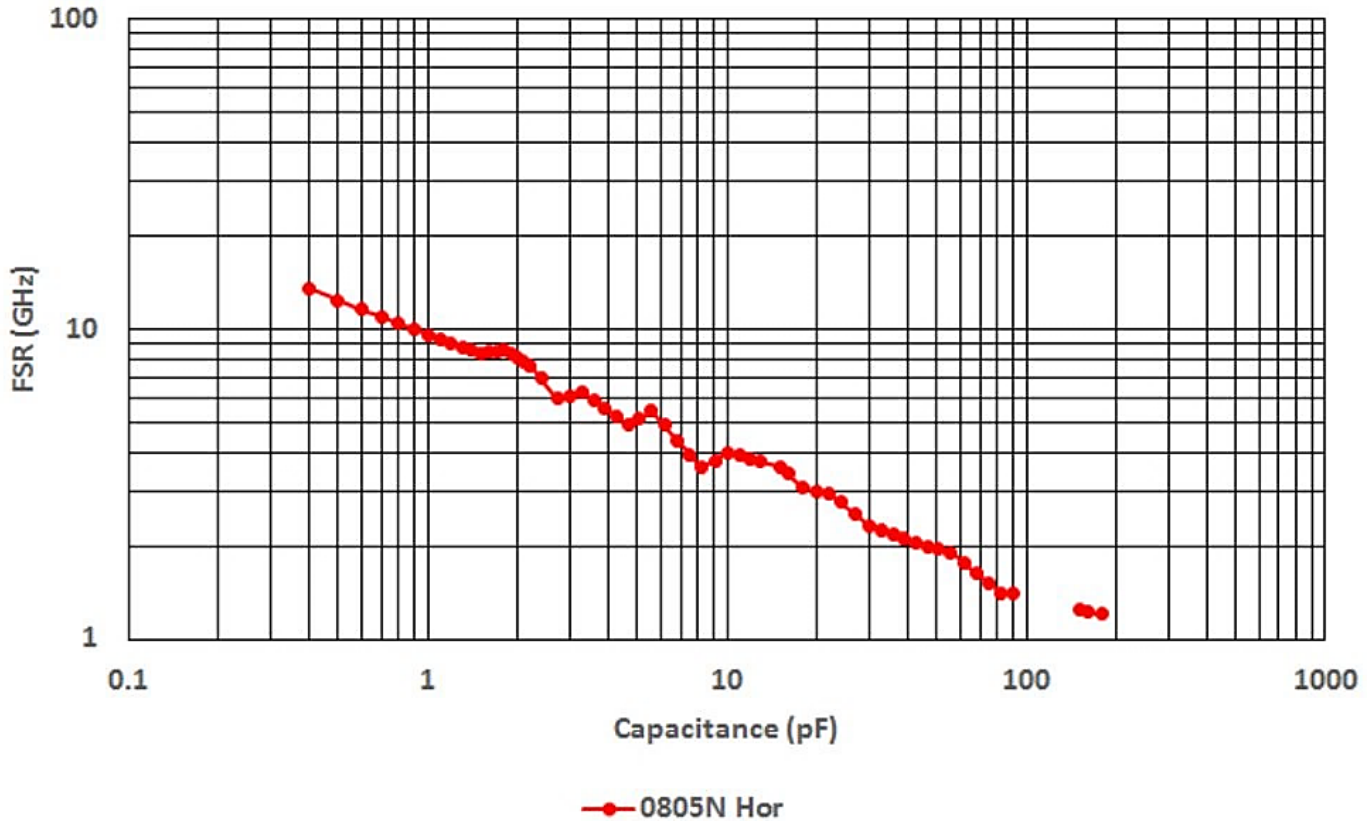

≠ Definitions and Measurement Conditions

The **First Series Resonance, FSR**, is defined as the lowest frequency at which the imaginary part of the input impedance, $\text{Im}[Z_{in}]$, equals zero. Should $\text{Im}[Z_{in}]$ or the real part of the input impedance, $\text{Re}[Z_{in}]$, not be monotonic with frequency at frequencies lower than those at which $\text{Im}[Z_{in}] = 0$, the FSR shall be considered as undefined (represented as a gap in the plot). FSR is dependent on internal capacitor structure; substrate thickness and dielectric constant; capacitor orientation, as defined alongside the FPR plot; and mounting pad dimensions.

The definitions on the charts are for a capacitor in a series configuration, i.e., mounted across a gap in a microstrip trace with 50-Ohm termination. The measurement conditions are: substrate – Rogers RO3003; substrate dielectric constant = 3.00; substrate thickness (mils) = 23; gap in microstrip trace (mils) = 23.6; microstrip trace width (mils) = 57.1; Reference planes at sample edges.

All data has been derived from electrical models created by Modelithics, Inc., a specialty vendor contracted by PPI. The models are derived from measurements on a large number of parts disposed on several different substrates.

⚡ Capacitor Application Program

Passive Plus, Inc.'s brand new **online Capacitor Application Program (C.A.P.)** helps Engineers and Designers select capacitors according to parameters such as cap value and frequency. C.A.P. allows engineers to insert capacitors requirements (Cap value, Frequency), producing Scattering Matrices (S2P) Charts while providing options (Case Size, Terminations, Mounting), and parameters (ESR, Q, Impedance) along with Datasheets. Once engineers have determined their capacitor requirements, C.A.P. also includes online Requests For Quotes (RFQs) and/or sample requests.

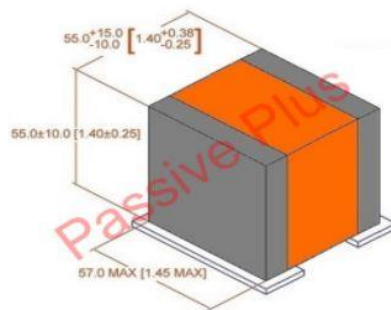

⚡ Modelithics Vendor Program

PPI offers design engineers a Free 90-Day Trial license for the Modelithics PPI Component Library. This program provides engineers access to extremely accurate scalable simulation models for Passive Plus capacitors with advanced features that enable a more precise and rapid design process.

Microwave Global Models include every part value in a series and permit users to input substrate thickness, dielectric constant, and loss tangent, as well as mounting pad layout dimensions. Selected models also include capacitor orientation – vertical or horizontal – as an input. Engineers can request FREE use of the models, by either visiting the [Passive Plus Resources page](http://passiveplus.com/addldocs_resources.php) (http://passiveplus.com/addldocs_resources.php).



≠ Recommended Land Pattern Dimensions

When mounting the capacitor to substrate, it's important to carefully consider that the amount of solder (size of fillet) used has a direct effect upon the capacitor once it's mounted.

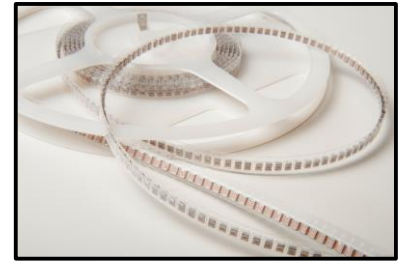

1) The greater the amount of solder, the greater the stress to the elements. This may cause the substrate to break or crack.

2) In the situation where two or more devices are mounted onto a common land, be sure to separate the device into exclusive pads by using soldering resist.

≠ Horizontal Mounting Dimensions: mm

A	B	C
1.10	1.10	1.40

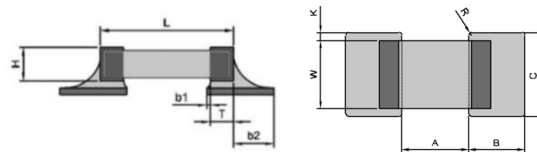

≠ Vertical Mounting Dimensions: mm

A	B	C
1.10	1.10	1.40

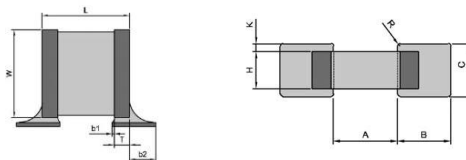

≠ Tape & Reel Specifications Dimensions: mm

Horizontal Orientation

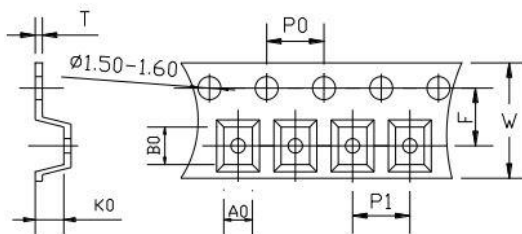

Vertical Orientation

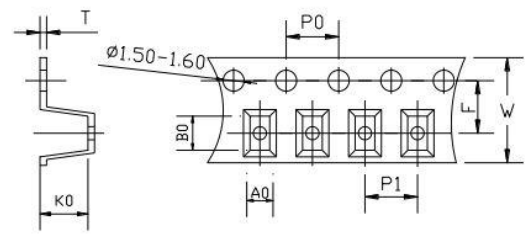

Orientation	A0	B0	K0	W	P0	P1	T	F	Qty Min	Qty/reel	Tape Material
Horizontal	1.60	1.60	2.40	8.00	4.00	4.00	0.20	3.50	500	500	Paper



EIA Low ESR
Multi-Layer Ceramic Capacitors

0805N (0.080" x 0.050")

≠ Engineering Design Kits

PPI offers Design Kits for engineers who are building and testing prototypes. Each kit contains 16 values; 10 pieces per value.

Kits are 100% RoHS compliant.



Kit Number	Value Range	Values	
DKD0805N01	0.1 - 2.0pF	0.1, 0.2, 0.3, 0.4, 0.5, 0.6, 0.7, 0.8, 0.9, 1.0, 1.2, 1.5, 1.6, 1.8, 2.0pF	
DKD0805N02	1.0 - 10pF	1.0, 1.2, 1.5, 1.8, 2.0, 2.2, 2.4, 2.7, 3.0, 3.3, 3.9, 4.7, 5.6, 6.8, 8.2, 10pF	
DKD0805N03	10 - 100pF	10, 12, 15, 18, 20, 22, 24, 27, 30, 33, 39, 47, 56, 68, 82, 100pF	
DKD0805N04	10 - 220pF	10, 15, 18, 20, 24, 27, 30, 39, 47, 56, 68, 82, 100, 120, 150, 180, 220pF	

DKD0805N01

0805N Series 0.1 — 2.0pF
Size: 0.080" x 0.050"
TC = NP0 WVDC = 250V

Hi-Q Low ESR Capacitor Design Kit

www.passiveplus.com

DKD0805N02

0805N Series 1.0 — 10pF
Size: 0.080" x 0.050"
TC = NP0 WVDC = 250V

Hi-Q Low ESR Capacitor Design Kit

www.passiveplus.com

DKD0805N03

0805N Series 10 — 100pF
Size: 0.080" x 0.050"
TC = NP0 WVDC = 250V

Hi-Q Low ESR Capacitor Design Kit

www.passiveplus.com

DKD0805N04

0805N Series 10 — 220pF
Size: 0.080" x 0.050"
TC = NP0 WVDC = 250V

Hi-Q Low ESR Capacitor Design Kit

www.passiveplus.com



Product Features

- High Q
- High Power
- Low ESR/ESL
- Low Noise
- High Self-Resonance
- Ultra Stable Performance
- Capacitance Range:
0.2pF to 1000pF

Product Applications

Typical Functional Applications

- Tuning • Bypass • Coupling
- Feedback • D.C. Blocking
- Impedance Matching

Typical Circuit Applications

- UHF/Microwave RF Power Amplifiers
- Mixers • Oscillators • Filter Networks
- Low Noise Amplifiers • Timing Circuits and Delay Lines

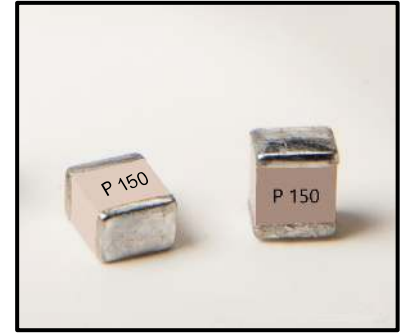

Marking shown for illustration purposes only. Actual marking may differ.

Part Numbering

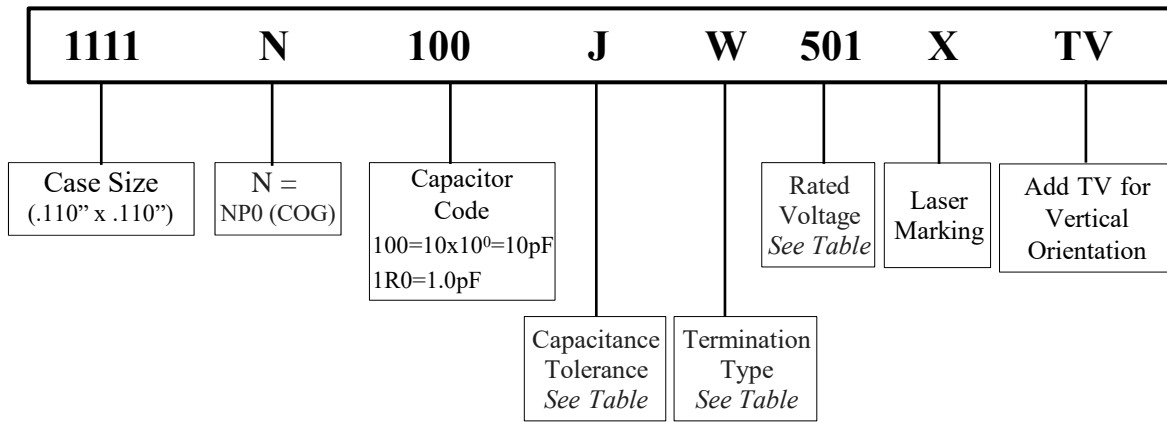

Capacitor Dimensions Unit: inch (millimeter)

Code	Term.	Length Lc	Width Wc	Thickness Tc	Overlap B
W	Chip	0.110 + 0.020 to -0.010 (2.79 +0.51 to -0.25)	0.110 ± 0.015 (2.79 ±0.38)	0.10 (2.60 max)	0.015 (0.024 max)

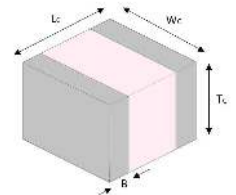

Capacitance Tolerance Codes

Code	A	B	C	D	F	G	J	K
Tol.	±0.05pF	±0.1pF	±0.25pF	±0.5pF	±1%	±2%	±5%	±10%



EIA Low ESR
Multi-Layer Ceramic Capacitors

1111N (0.110" x 0.110")

≠ Terminations Types and Codes

Termination Code	Termination
W	100% Sn Solder over Nickel Plating
L	90%Sn10%Pb Tin/Lead

≠ Voltage Code

Voltage	Code
100V	101
200V	201
500V	501
1000V	102

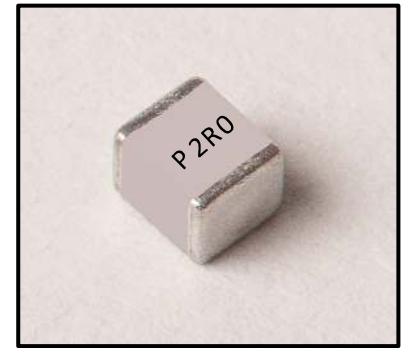

Marking shown for illustration purposes only.
Actual marking may differ.

≠ 1111N Capacitance Values

For special capacitances, tolerances and WVDC, please contact PPI.

Cap. pF	Cap Code	Tol.	Rated WVDC		Cap. pF	Cap Code	Tol.	Rated WVDC		Cap. pF	Cap Code	Tol.	Rated WVDC		Cap. pF	Cap Code	Tol.	Rated WVDC	
			Std.	Ext.				Std.	Ext.				Std.	Ext.				Std.	Ext.
0.2	0R2	A,B, C,D	500V	1000V	2.7	2R7	A,B, C,D	500V	1000V	22	220	F,G, J,K	500V	1000V	180	181	F,G, J,K	500V	1000V
0.3	0R3				3.0	3R0				24	240				200	201			
0.4	0R4				3.3	3R3				27	270				220	221			
0.5	0R5				3.6	3R6				30	300				240	241			
0.6	0R6				3.9	3R9				33	330				270	271			
0.7	0R7				4.3	4R3				36	360				300	301			
0.8	0R8				4.7	4R7				39	390				330	331			
0.9	0R9				5.1	5R1				43	430				360	361			
1.0	1R0				5.6	5R6				47	470				390	391			
1.1	1R1				6.2	6R2				51	510				430	431			
1.2	1R2	B,C, D	500V	1000V	56	560	F,G, J,K	500V	1000V	470	471	G,J, K	200V	500V	510	511	G,J, K	100V	500V
1.3	1R3				7.5	7R5				62	620				560	561			
1.4	1R4				8.2	8R2				68	680				620	621			
1.5	1R5				9.1	9R1				75	750				680	681			
1.6	1R6				10	100				82	820				750	751			
1.7	1R7				11	110				91	910				820	821			
1.8	1R8				12	120				100	101				910	911			
1.9	1R9				13	130				110	111				1000	102			
2.0	2R0				15	150				120	121								
2.1	2R1				16	160				130	131								
2.2	2R2	18	180	150	151														
2.4	2R4	20	200	160	161														



≠ Electrical Specifications

Quality Factor (Q)	2,000 at 1 MHz
Insulation Resistance (IR)	10 ⁵ Megaohms min. @ +25°C rated WVDC 10 ⁴ Megaohms min. @ +125°C rated WVDC
Rated Voltage	See Rated Voltage Table
Dielectric Withstanding Voltage (WVDC)	250% of Rated Voltage of 5 seconds, Rated Voltage ≤ 500VDC 150% of Voltage for 5 seconds, 500VDC < Rated Voltage ≤ 1250 VDC 120% of Voltage for 5 seconds, Rated Voltage > 1250 VDC
Operating Temperature Range	-55°C to 175°C
Temperature Coefficient (TC)	0±30ppm/°C
Capacitance Drift	±0.02% or ±0.02pF, whichever is greater
Piezoelectric Effects	None

≠ Environmental Specifications

Specification	Test Parameters
Thermal Shock No mechanical damage Capacitance Change: ±0.5% or 0.5pF max IR: >1 G Ohms Q>500	MIL-STD-202, Method 107, Condition A. At the maximum rated temperature (-55°C and 175°C) stay 30 minutes, the time of removing shall not be more than 3 minutes. Perform five cycles.
Moisture Resistance Breakdown Voltage: 2.5x WVDC	MIL-STD-202, Method 106
Humidity (Steady State) No mechanical damage Capacitance Change: ±0.5% or 0.5pF max IR: >1 G Ohms Q>300 Breakdown Voltage: 2.5x WVDC	MIL-STD-202, Method 103, Condition A With 1.5Volts DC applied while subjected to an environment of 85°C with 85% relative humidity for 240 hours minimum.
Life No mechanical damage Capacitance Change: ±2.0% or 0.5pF max IR: >1 G Ohms Q>500 Breakdown Voltage: 2.5x WVDC	MIL-STD-202, Method 108. For 1000 hours, at 175°C. 200% of Voltage for Capacitors, Rated Voltage ≤ 500VDC; 120% of Voltage for Capacitors, 500VDC < Rated Voltage ≤ 1250VDC; 100% for Voltage for Capacitors, Rated Voltage > 1250VDC
Terminal Adhesion Termination should not pull off. Ceramic should remain undamaged	Linear pull force exerted on axial leads soldered to each terminal. 2.0lbs.
Resistance to Soldering Heat No mechanical damage Capacitance Change: -1.0%~+2.0 IR: >1 G Ohms Q>500 Breakdown Voltage: 2.5x WVDC	Preheat device to 150°C -180°C for 60 seconds. Dip in 260°C ±5C solder for 10 ±1 second. Measure after 24± 2 hour cooling period.

Capacitors are designed and manufactured to meet the requirements of MIL-PRF-55681 and MIL-PRF-123.

≠ ESR vs. Frequency

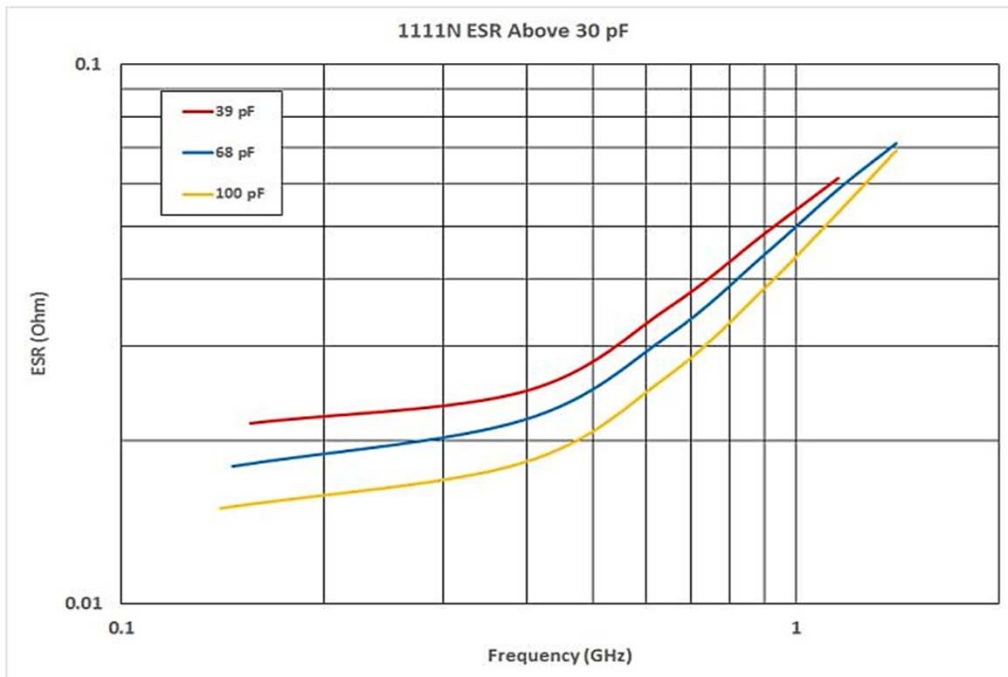
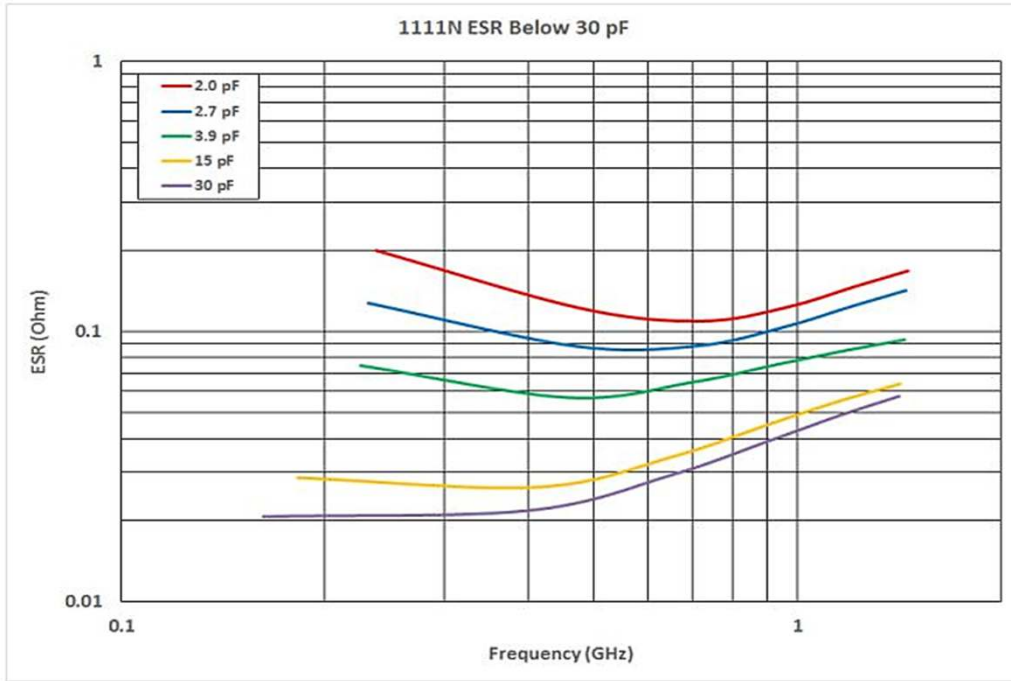

≠ First Parallel Resonance

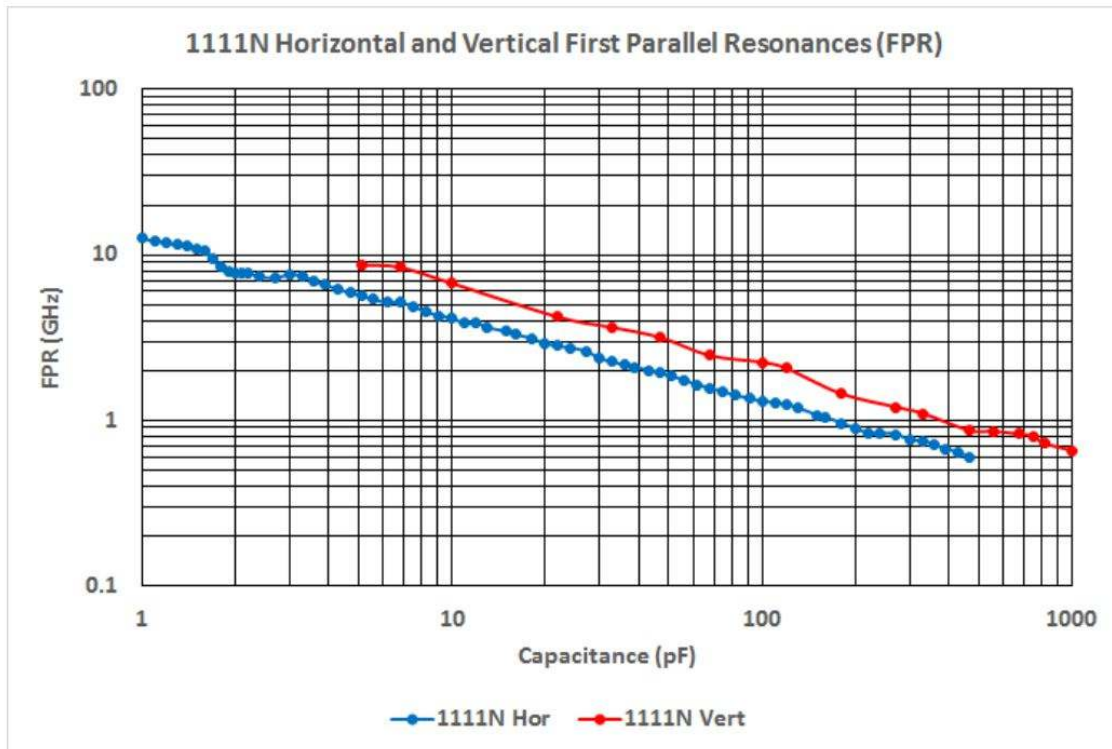

≠ Definitions and Measurement Conditions

The **First Parallel Resonance, FPR**, is defined as the lowest frequency at which a suckout or notch appears in $|S_{21}|$. It is generally independent of substrate thickness or dielectric constant, but does depend on capacitor orientation. A horizontal orientation means the capacitor electrode planes are parallel to the plane of the substrate; a vertical orientation means the electrode planes are perpendicular to the substrate.

The definitions on the carts are for a capacitor in a series configuration, i.e., mounted across a gap in a microstrip trace with a 50-Ohm termination. The measurement conditions are: substrate – Rogers RO4350; substrate dielectric constant = 3.48; horizontal mount substrate thickness (mils) = 55; vertical mount substrate thickness (mils) = 45; gap in microstrip trace (mils) = 61.1; horizontal mount microstrip trace width (mils) = 123.7; vertical mount microstrip trace width (mils) = 101.0. Reference planes at sample edges.

All data has been derived from electrical models created by Modelithics, Inc., a specialty vendor contracted by PPI. The models are derived from measurements on a large number of parts disposed on several different substrates.

≠ First Series Resonance

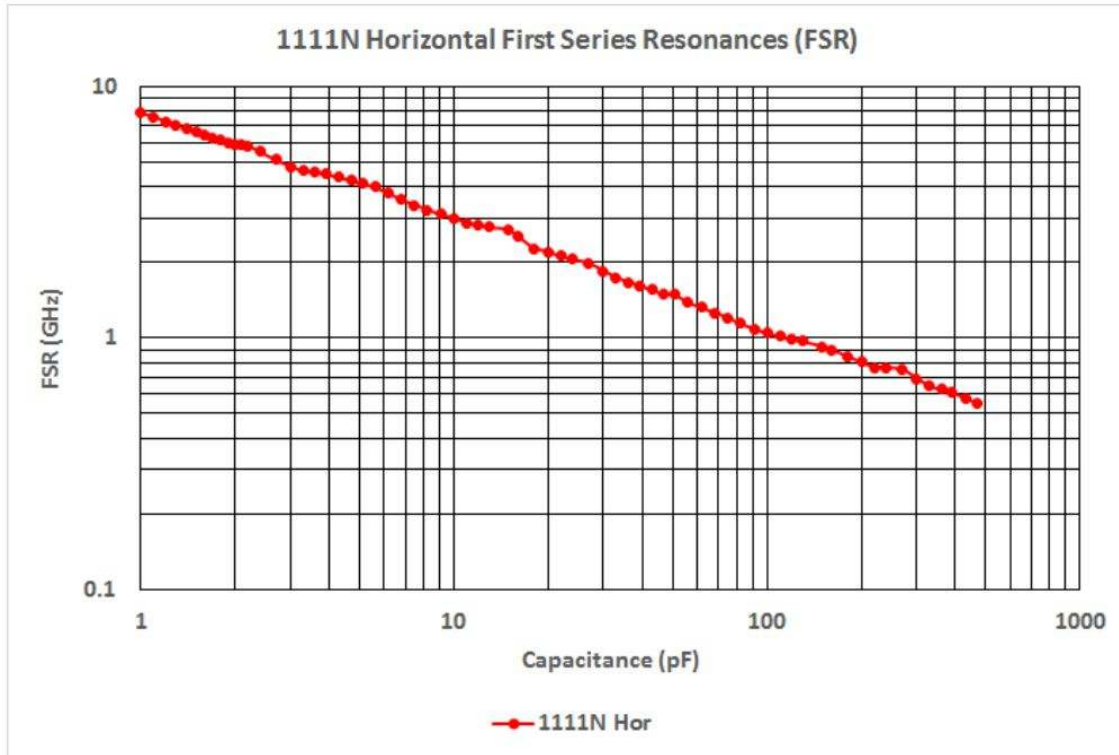

≠ Definitions and Measurement Conditions

The **First Series Resonance, FSR**, is defined as the lowest frequency at which the imaginary part of the input impedance, $\text{Im}[Z_{in}]$, equals zero. Should $\text{Im}[Z_{in}]$ or the real part of the input impedance, $\text{Re}[Z_{in}]$, not be monotonic with frequency at frequencies lower than those at which $\text{Im}[Z_{in}] = 0$, the FSR shall be considered as undefined (represented as a gap in the plot). FSR is dependent on internal capacitor structure; substrate thickness and dielectric constant; capacitor orientation, as defined alongside the FPR plot; and mounting pad dimensions.

The definitions on the carts are for a capacitor in a series configuration, i.e., mounted across a gap in a microstrip trace with a 50-Ohm termination. The measurement conditions are: substrate – Rogers RO4350; substrate dielectric constant = 3.48; horizontal mount substrate thickness (mils) = 55; vertical mount substrate thickness (mils) = 45; gap in microstrip trace (mils) = 61.1; horizontal mount microstrip trace width (mils) = 123.7; vertical mount microstrip trace width (mils) = 101.0. Reference planes at sample edges.

All data has been derived from electrical models created by Modelithics, Inc., a specialty vendor contracted by PPI. The models are derived from measurements on a large number of parts disposed on several different substrates.

⚡ Capacitor Application Program

Passive Plus, Inc.'s brand new **online Capacitor Application Program (C.A.P.)** helps Engineers and Designers select capacitors according to parameters such as cap value and frequency. C.A.P. allows engineers to insert capacitors requirements (Cap value, Frequency), producing Scattering Matrices (S2P) Charts while providing options (Case Size, Terminations, Mounting), and parameters (ESR, Q, Impedance) along with Datasheets. Once engineers have determined their capacitor requirements, C.A.P. also includes online Requests For Quotes (RFQs) and/or sample requests.

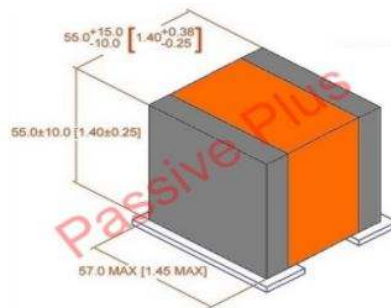

⚡ Modelithics Vendor Program

PPI offers design engineers a Free 90-Day Trial license for the Modelithics PPI Component Library. This program provides engineers access to extremely accurate scalable simulation models for Passive Plus capacitors with advanced features that enable a more precise and rapid design process.

Microwave Global Models include every part value in a series and permit users to input substrate thickness, dielectric constant, and loss tangent, as well as mounting pad layout dimensions. Selected models also include capacitor orientation – vertical or horizontal – as an input. Engineers can request FREE use of the models, by either visiting the [Passive Plus Resources page](http://passiveplus.com/addldocs_resources.php) (http://passiveplus.com/addldocs_resources.php).



≠ Recommended Land Pattern Dimensions

When mounting the capacitor to substrate, it's important to carefully consider that the amount of solder (size of fillet) used has a direct effect upon the capacitor once it's mounted.



- 1) The greater the amount of solder, the greater the stress to the elements. This may cause the substrate to break or crack.
- 2) In the situation where two or more devices are mounted onto a common land, be sure to separate the device into exclusive pads by using soldering resist.

≠ Horizontal Mounting Dimensions: mm

A	B	C
1.90	1.70	2.90

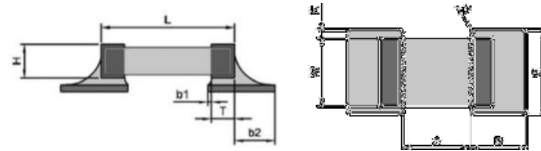

≠ Vertical Mounting Dimensions: mm

A	B	C
1.90	1.70	2.50

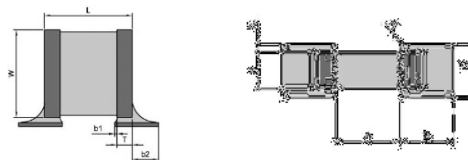

≠ Tape & Reel Specifications Dimensions: mm

Horizontal Orientation

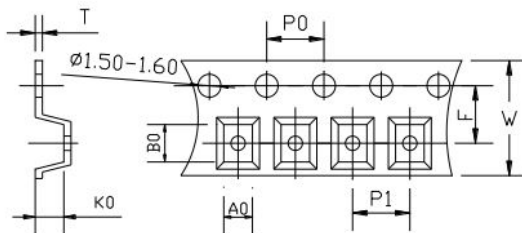

Vertical Orientation

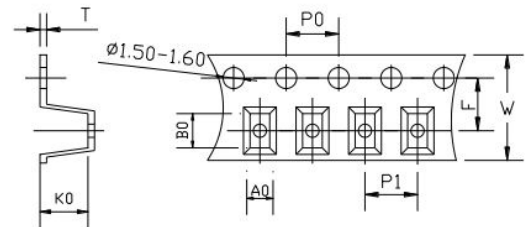

Orientation	A0	B0	K0	W	P0	P1	T	F	Qty Min	Qty/reel	Tape Material
Horizontal	2.92	3.51	2.34	8.00	4.00	4.00	0.254	3.50	500	500	Embossed
Vertical	2.92	3.51	2.34	12.00	4.00	4.00	0.254	3.50	500	500	Embossed

Dimensions: mm



EIA Low ESR
Multi-Layer Ceramic Capacitors

1111N (0.110" x 0.110")

≠ Engineering Design Kits

PPI offers Design Kits for engineers who are building and testing prototypes. Each kit contains 16 values; 10 pieces per value.

Kits are 100% RoHS compliant.



Kit Number	Value Range	Values	
DKD1111N01	1.0 - 10pF	1.0, 1.2, 1.5, 1.8, 2.0, 2.2, 2.4, 2.7, 3.0, 3.3, 3.9, 4.7, 5.6, 6.8, 8.2, 10pF	
DKD1111N02	10 - 100pF	10, 12, 15, 18, 20, 22, 24, 27, 30, 33, 39, 47, 56, 68, 82, 100pF	
DKD1111N03	100 - 1000pF	100, 120, 150, 180, 200, 220, 240, 270, 300, 330, 390, 470, 560, 680, 820, 1000pF	

PPI
Passive Plus Inc.
RF & Microwave Components

DKD1111N01

1111N Series 1.0 — 10pF
Size: 0.110" x 0.110"
TC = NP0 WVDC = 500V

Hi-Q Low ESR Capacitor Design Kit

www.passiveplus.com

PPI
Passive Plus Inc.
RF & Microwave Components

DKD1111N02

1111N Series 10 — 100pF
Size: 0.110" x 0.110"
TC = NP0 WVDC = 500V

Hi-Q Low ESR Capacitor Design Kit

www.passiveplus.com

PPI
Passive Plus Inc.
RF & Microwave Components

DKD1111N03

1111N Series 100 — 1000pF
Size: 0.110" x 0.110"
TC = NP0 WVDC = 500V

Hi-Q Low ESR Capacitor Design Kit

www.passiveplus.com



Custom & Engineering Design Kits

PPI
Passive Plus Inc.
RF & Microwave Components

DKD0201N01

0201N Series 0.1 — 2.0pF
Size: 0.020" x 0.010"
TC = NP0 WVDC = 50V

Hi-Q Low ESR Capacitor Design Kit



PPI
Passive Plus Inc.
RF & Microwave Components

DKD0402N01

0402N Series 0.1 — 2.0pF
Size: 0.040" x 0.020"
TC = NP0 WVDC = 200V

Hi-Q Low ESR Capacitor Design Kit



PPI
Passive Plus Inc.
RF & Microwave Components

DKD0603N01

0603N Series 0.1 — 2.0pF
Size: 0.060" x 0.030"
TC = NP0 WVDC = 250V

Hi-Q Low ESR Capacitor Design Kit



www.passiveplus.com

PPI
Passive Plus Inc.
RF & Microwave Components

DKD0805N01

0805N Series 0.1 — 2.0pF
Size: 0.080" x 0.050"
TC = NP0 WVDC = 250V

Hi-Q Low ESR Capacitor Design Kit



www.passiveplus.com

PPI
Passive Plus Inc.
RF & Microwave Components

DKD1111N01

1111N Series 1.0 — 10pF
Size: 0.110" x 0.110"
TC = NP0 WVDC = 500V

Hi-Q Low ESR Capacitor Design Kit



www.passiveplus.com

PPI
Passive Plus Inc.
RF & Microwave Components

DKD0505C01

0505C Series 0.1 — 2.0pF
Size: 0.055" x 0.055"
TC = NP0 WVDC = 150V

Hi-Q Low ESR Capacitor Design Kit



PPI
Passive Plus Inc.
RF & Microwave Components

DKD1111C01

1111C Series 1.0 — 10pF
Size: 0.110" x 0.110"
TC = NP0 WVDC = 500V

Hi-Q Low ESR Capacitor Design Kit



www.passiveplus.com

PPI
Passive Plus Inc.
RF & Microwave Components

DKD0505P01

0505P Series 0.1 — 2.0pF
Size: 0.055" x 0.055"
TC = P90 WVDC = 150V

Hi-Q Low ESR Capacitor Design Kit



www.passiveplus.com



0505 & 1111 case size kits
are available in
Magnetic & Non-Magnetic
Terminations

PPI
Passive Plus Inc.
RF & Microwave Components

DKD1111P01

1111P Series 1.0 — 10pF
Size: 0.110" x 0.110"
TC = P90 WVDC = 500V

Hi-Q Low ESR Capacitor Design Kit



www.passiveplus.com



Engineering Design Kits

According to the customer’s demand, PPI can provide many kinds of tool kits for engineers to design and debug the circuit. All of our products satisfy the requirement of RoHS instruction.

PPI also offers kits for Non-Magnetic MRI applications. Engineering design kits are also available in multiple sizes as well. All kits are RoHS Compliant.

Standard Values updated in 2022.



≠ High Q Capacitor Design Kits

Kit Number		Value Range	Values
MAGNETIC	NON-MAGNETIC		
DKD0505C01 DKD0505P01	DKD0505C05 DKD0505P05	0.1 - 2.0pF	0.1, 0.2, 0.3, 0.4, 0.5, 0.6, 0.7, 0.8, 0.9, 1.0, 1.2, 1.5, 1.6, 1.8, 2.0pF
DKD0505C02 DKD0505P02	DKD0505C06 DKD0505P06	1 - 10pF	1.0, 1.2, 1.5, 1.8, 2.0, 2.2, 2.4, 2.7, 3.0, 3.3, 3.9, 4.7, 5.6, 6.8, 8.2, 10pF
DKD0505C03 DKD0505P03	DKD0505C07 DKD0505P07	10 - 100pF	10, 12, 15, 18, 20, 22, 24, 27, 30, 33, 39, 47, 56, 68, 82, 100pF
DKD0505C04	DKD0505C08	100 - 1000pF	100, 120, 150, 180, 200, 220, 240, 270, 300, 330, 390, 470, 560, 680, 820, 1000pF
DKD1111C01 DKD1111P01	DKD1111C05 DKD1111P05	1.0 - 10pF	1.0, 1.2, 1.5, 1.8, 2.0, 2.2, 2.4, 2.7, 3.0, 3.3, 3.9, 4.7, 5.6, 6.8, 8.2, 10pF
DKD1111C02 DKD1111P02	DKD1111C06 DKD1111P06	10 - 100pF	10, 12, 15, 18, 20, 22, 24, 27, 30, 33, 39, 47, 56, 68, 82, 100pF
DKD1111C03 DKD1111P03	DKD1111C07 DKD1111P07	100 - 1000pF	100, 120, 150, 180, 200, 220, 240, 270, 300, 330, 390, 470, 560, 680, 820, 1000pF
DKD1111C04 DKD1111P04	DKD1111C08 DKD1111P08	1000 - 10000pF	1000, 1100, 1200, 1500, 1800, 2000, 2200, 2700, 3000, 3300, 3900, 4700, 5100, 5600, 10000pF

**⚡ EIA Low ESR Design Kits**

Kit Number	Value Range	Values
DKD0201N01	0.1 - 2.0pF	0.1, 0.2, 0.3, 0.5, 0.7, 0.8, 0.9, 1.0, 1.3, 1.5, 1.7, 1.9, 2.0pF
DKD0201N02	1.0 - 10pF	1.0, 1.3, 1.5, 1.7, 1.9, 2.0, 2.2, 2.7, 3.0, 3.9, 4.7, 5.6, 6.8, 7.5, 8.2, 10pF
DKD0201N03	10 - 100pF	10, 13, 15, 18, 20, 22, 27, 30, 39, 47, 56, 68, 75, 82, 91, 100pF
DKD0402N01	0.1 - 2.0pF	0.1, 0.2, 0.3, 0.4, 0.5, 0.6, 0.7, 0.8, 0.9, 1.0, 1.2, 1.5, 1.6, 1.8, 2.0pF
DKD0402N02	1.0 - 10pF	1.0, 1.2, 1.5, 1.8, 2.0, 2.2, 2.4, 2.7, 3.0, 3.3, 3.9, 4.7, 5.6, 6.8, 8.2, 10pF
DKD0402N03	10 - 33pF	10, 12, 13, 15, 16, 18, 20, 22, 24, 27, 30, 33pF
DKD0603N01	0.1 - 2.0pF	0.1, 0.2, 0.3, 0.4, 0.5, 0.6, 0.7, 0.8, 0.9, 1.0, 1.1, 1.2, 1.5, 1.6, 1.8, 2.0pF
DKD0603N02	1.0 - 10pF	1.0, 1.2, 1.5, 1.8, 2.0, 2.2, 2.4, 2.7, 3.0, 3.3, 3.9, 4.7, 5.6, 6.8, 8.2, 10pF
DKD0603N03	10 - 100pF	10, 12, 15, 18, 20, 22, 24, 27, 30, 33, 39, 47, 56, 68, 100pF
DKD0805N01	0.1 - 2.0pF	0.1, 0.2, 0.3, 0.4, 0.5, 0.6, 0.7, 0.8, 0.9, 1.0, 1.2, 1.5, 1.6, 1.8, 2.0pF
DKD0805N02	1.0 - 10pF	1.0, 1.2, 1.5, 1.8, 2.0, 2.2, 2.4, 2.7, 3.0, 3.3, 3.9, 4.7, 5.6, 6.8, 8.2, 10pF
DKD0805N03	10 - 100pF	10, 12, 15, 18, 20, 22, 24, 27, 30, 33, 39, 47, 56, 68, 82, 100pF
DKD0805N04	10 - 220pF	10, 15, 18, 20, 24, 27, 30, 39, 47, 56, 68, 82, 100, 120, 150, 180, 220pF
DKD1111N01	1.0 - 10pF	1.0, 1.2, 1.5, 1.8, 2.0, 2.2, 2.4, 2.7, 3.0, 3.3, 3.9, 4.7, 5.6, 6.8, 8.2, 10pF
DKD1111N02	10 - 100pF	10, 12, 15, 18, 20, 22, 24, 27, 30, 33, 39, 47, 56, 68, 82, 100pF
DKD1111N03	100 - 1000pF	100, 120, 150, 180, 200, 220, 240, 270, 300, 330, 390, 470, 560, 680, 820, 1000pF

Custom Kits

According to the customer's demand, PPI can provide many kinds of tool kits for engineers to design and debug the circuit. All our products satisfy the requirement of RoHS instruction.

Passive Plus will develop a custom kit using the engineer's specific requirements for the engineer's projects (case size, temperature coefficient, value range, tolerances, voltages, and quantities per value). Once these requirements are determined, PPI will then provide customer with a price. Please contact PPI directly to start this process.

All kits are RoHS Compliant.





Custom & Engineering Design Kits

Custom Kits





X7R RF By-Pass Capacitors

0505X (0.055" x 0.055")

≠ Product Features

- High Q
- High Power
- Low ESR/ESL
- Low Noise
- High Self-Resonance
- Ultra Stable Performance
- Capacitance Range:
470pF to 10000pF

≠ Product Applications

Typical Functional Applications:

- Tuning • Bypass • Coupling
- Feedback • D.C. Blocking
- Impedance Matching

Typical Circuit Applications:

- UHF/Microwave RF Power Amplifiers
- Mixers • Oscillators • Filter Networks
- Low Noise Amplifiers • Timing Circuits and Delay Lines



≠ Part Numbering

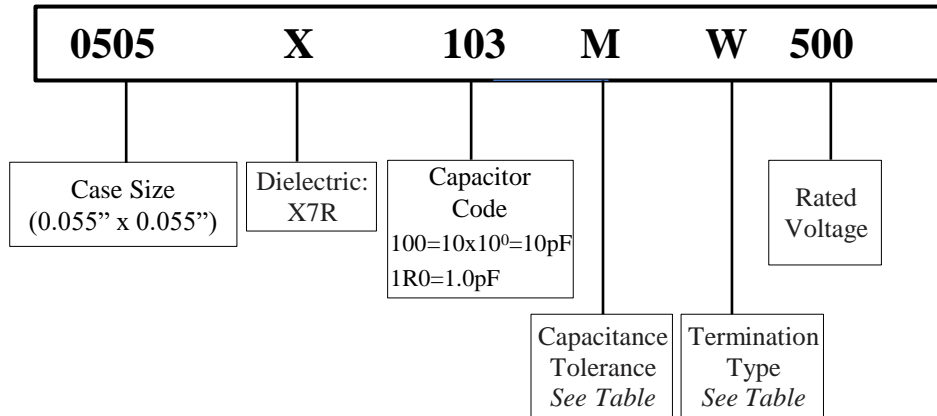

≠ Capacitor Dimensions

Unit: inch (millimeter)

Length	Width	Thickness	Overlap
Lc	Wc	Tc	B
0.055 + 0.015 to -0.010 (1.40 +0.38 to -0.25)	0.055 ± .010 (1.40 ±0.25)	0.057 (1.45 max)	0.014 ± 0.006 (0.356 ± 0.152)

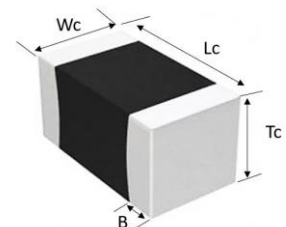



≠ 0505X Capacitance Values

Cap. pF	Cap Code	Tol.	Rated WVDC	Cap. pF	Cap Code	Tol.	Rated WVDC	Cap. pF	Cap Code	Tol.	Rated WVDC
470	471			1500	152			4700	472		
560	561			1800	182			5000	502		
680	681	K,M	50V	2200	222	K,M	50V	5600	562	K,M	50V
820	821			2700	272			6800	682		
1000	102			3300	332			8200	822		
1200	122			3900	392			10000	103		

Special capacitances, tolerances and WVDC are available. Please contact PPI.

≠ Capacitance Tolerance Codes

Code	K	M
Tol.	±10%	±20%

≠ Termination Types

Termination Code	Plated Material
W	Sn/Ni
L	90% Sn10%Pb
P (Non-Magnetic)	Sn/ Cu
C	Ag/Pb
G	Au/Ni



Note: "Non-Magnetic" means no magnetic materials.

≠ Electrical Specifications

Operating Temperature Range	-55°C to +125°C
Insulation Resistance (IR)	Insulation Resistance @ +25°C > 1000ΩF Insulation Resistance @ +125°C > 100ΩF
Temperature Voltage Coefficient	+15/-25% ΔC (-55°C to +125°C)
Dielectric Withstanding Voltage (DWV)	2.5x WVDC, 5 seconds
Max Dissipation Factor	0.025 (2.5%) max
Test Parameters	1kHz, 1.0 VRMS, 25°C

≠ Q vs. Frequency

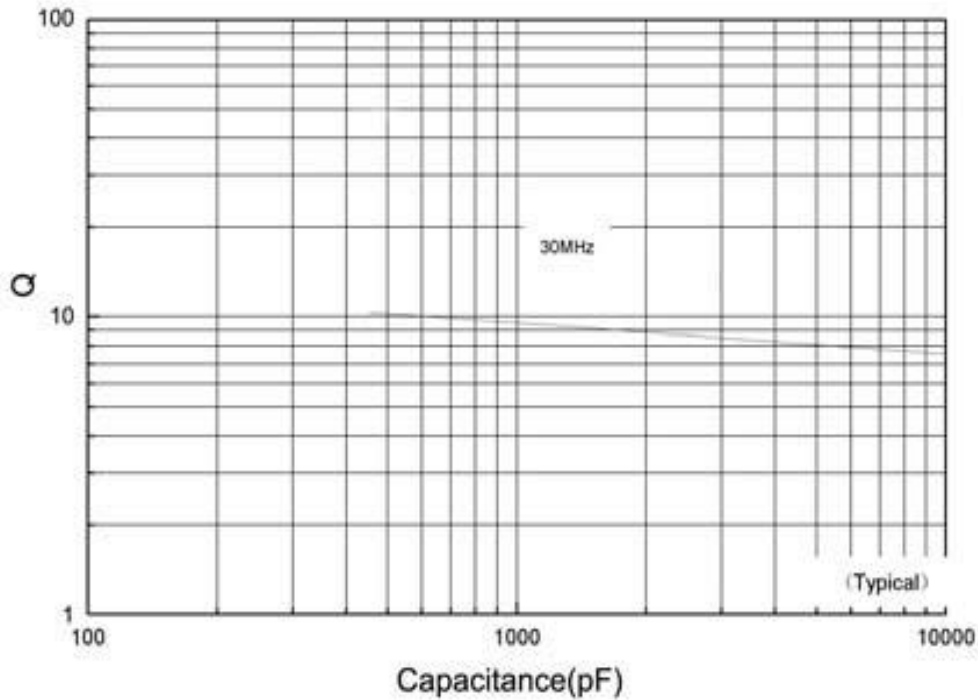

≠ Current Rating vs. Capacitance

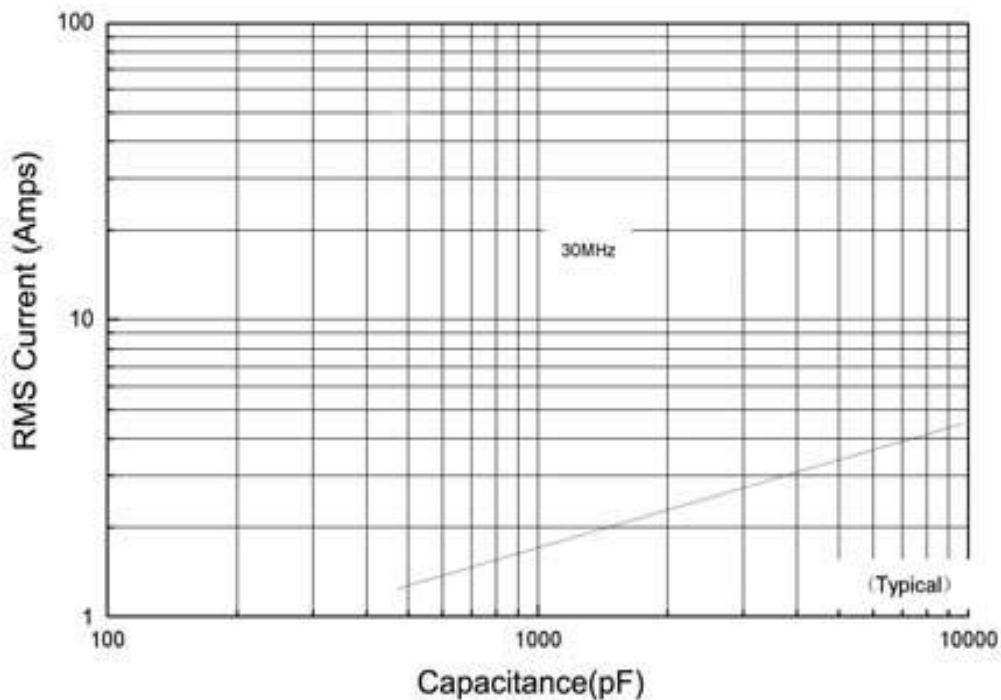

⚡ ESR vs Capacitance

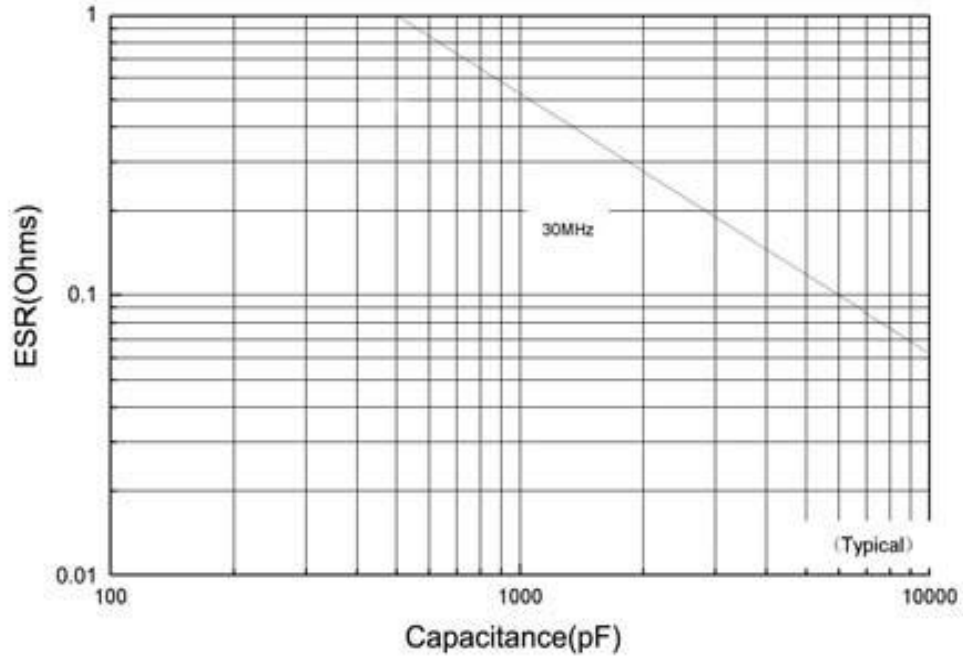

⚡ Series Resonance vs. Capacitance

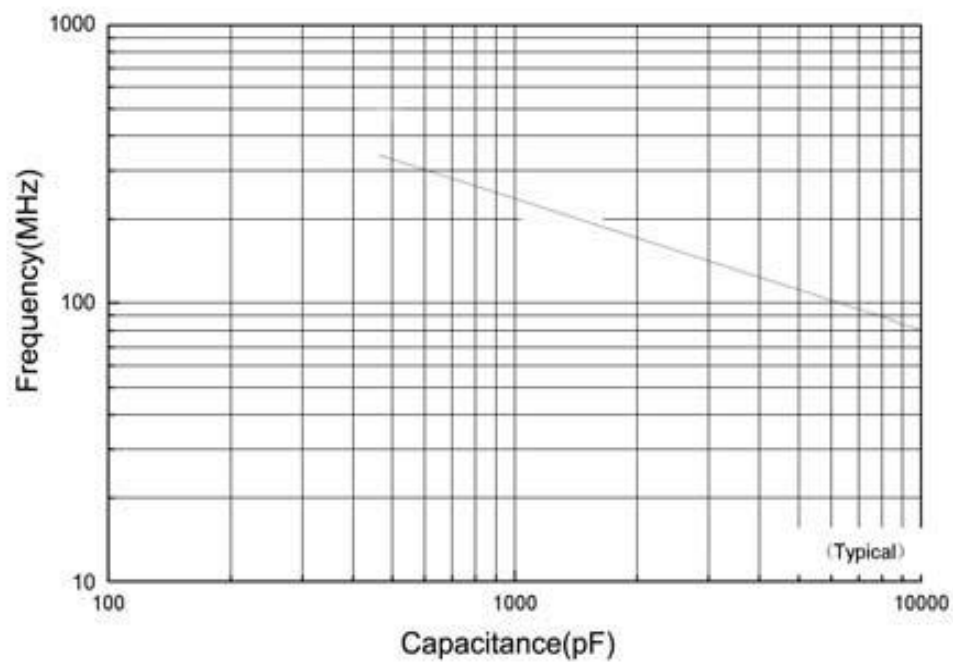

≠ Mounting Pad Recommendations

Orientation	A Min	B Min	C Min	D Min
Vertical	0.070"	0.050"	0.030"	0.130"
Horizontal	0.080"	0.050"	0.030"	0.130"

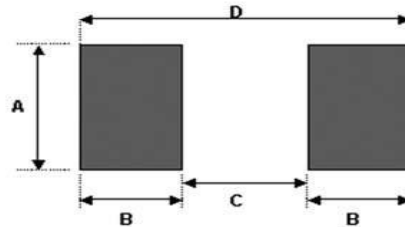

≠ Tape & Reel Specifications (mm)

Horizontal Orientation

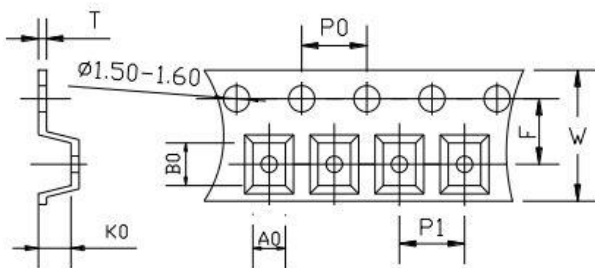

Orientation	W	P0	P1	T	F	Qty Min	Qty/reel	Tape Material
Horizontal	8.00	4.00	4.00	0.22	3.50	500	3000	Plastic

A₀ B₀ K₀

- Determined by component size. Typical clearance between the cavity and the component is:
.05 (.002) min to .50 (.020) max for 8mm tape and .50 (.002) min to .65 (.026) max for 12mm tape.
- The component cannot rotate more than 20° within the determined cavity.



≠ Product Features

- High Q
- High Power
- Low ESR/ESL
- Low Noise
- High Self-Resonance
- Ultra Stable Performance
- Capacitance Range:
4700pF to 100nF

≠ Product Applications

Typical Functional Applications:

- Tuning • Bypass • Coupling
- Feedback • D.C. Blocking
- Impedance Matching

Typical Circuit Applications:

- UHF/Microwave RF Power Amplifiers
- Mixers • Oscillators • Filter Networks
- Low Noise Amplifiers • Timing Circuits and Delay Lines



≠ Part Numbering

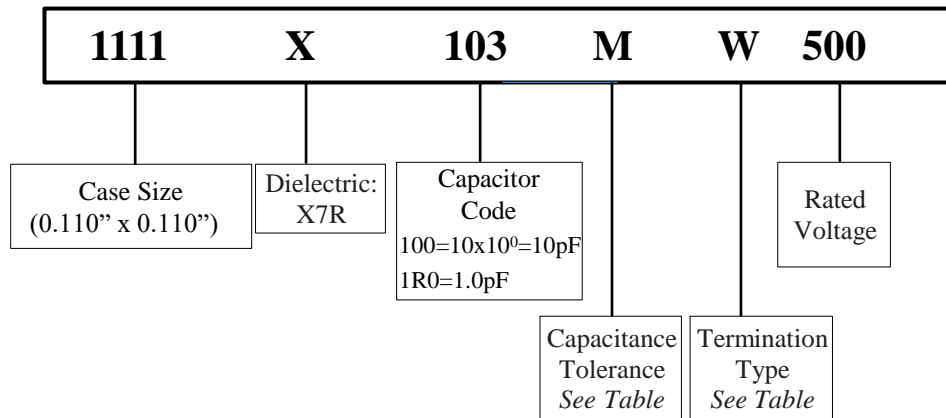

≠ Capacitor Dimensions

Unit: inch (millimeter)

Length	Width	Thickness	Overlap
Lc	Wc	Tc	B
0.110+0.025~ -.010 (2.79+0.64~ -.25)	0.110±0.015 (2.79±0.38)	0.102 (2.59 max)	0.020 ± 0.010 (0.508 ± 0.250)

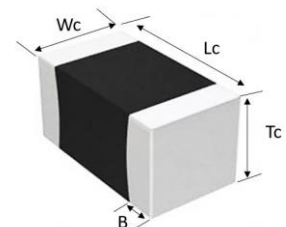



≠ 1111X Capacitance Values

Cap. pF	Cap Code	Tol.	Rated WVDC	Cap. pF	Cap Code	Tol.	Rated WVDC	Cap. pF	Cap Code	Tol.	Rated WVDC
4700	472	K,M	50V	15000	153	K,M	50V	47000	473	K,M	50V
5600	562			18000	183			50000	503		
6800	682			22000	223			56000	563		
8200	822			27000	273			68000	683		
10000	103			33000	333			82000	823		
12000	123			39000	393			100000	104		

Special capacitances, tolerances and WVDC are available. Please contact PPI.

≠ Capacitance Tolerance Codes

Code	K	M
Tol.	±10%	±20%

≠ Termination Types

Termination Code	Plated Material
W	Sn/Ni
L	90% Sn10%Pb
P (Non-Magnetic)	Sn/ Cu
C	Ag/Pb
G	Au/Ni



Note: "Non-Magnetic" means no magnetic materials.

≠ Electrical Specifications

Operating Temperature Range	-55°C to +125°C
Insulation Resistance (IR)	Insulation Resistance @ +25°C > 1000ΩF Insulation Resistance @ +125°C > 100ΩF
Temperature Voltage Coefficient	+15/-25% ΔC (-55°C to +125°C)
Dielectric Withstanding Voltage (DWV)	2.5x WVDC, 5 seconds
Max Dissipation Factor	0.025 (2.5%) max
Test Parameters	1kHz, 1.0 VRMS, 25°C

≡ Q vs. Frequency

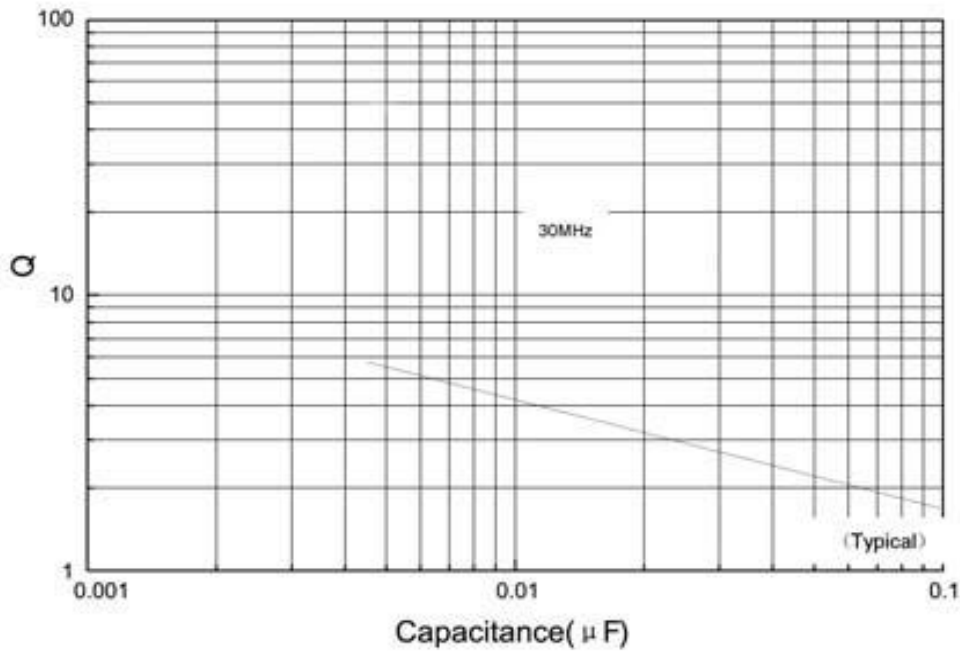

≡ Current Rating vs. Capacitance

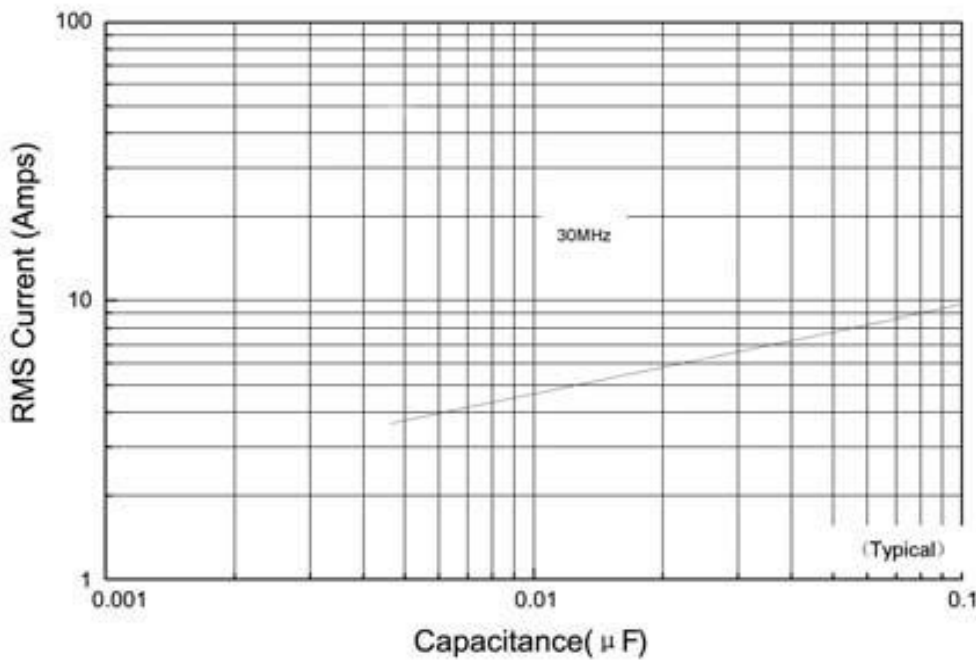

≠ ESR vs Capacitance

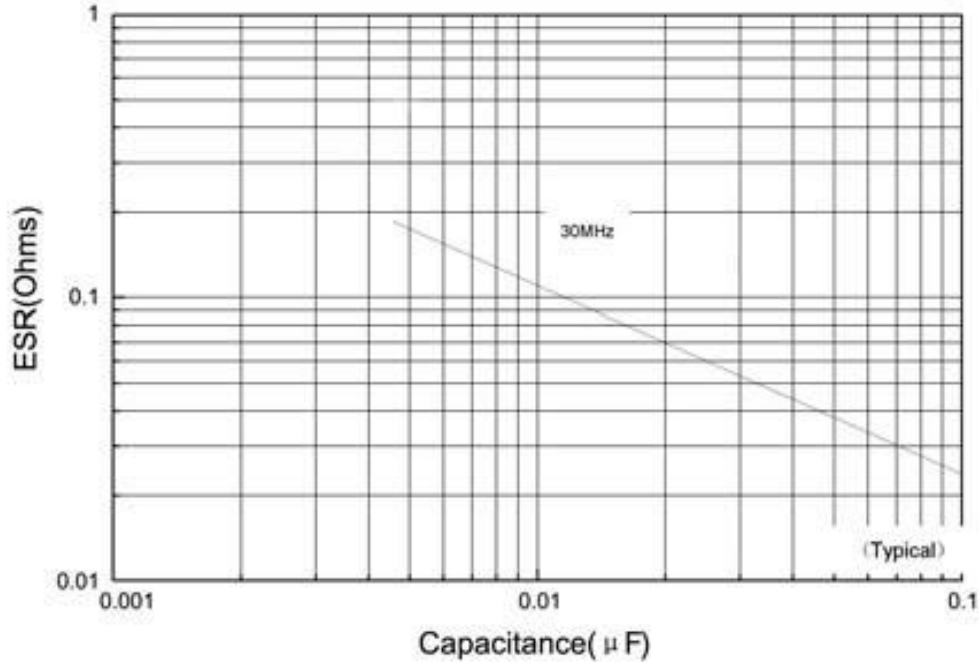

≠ Series Resonance vs. Capacitance

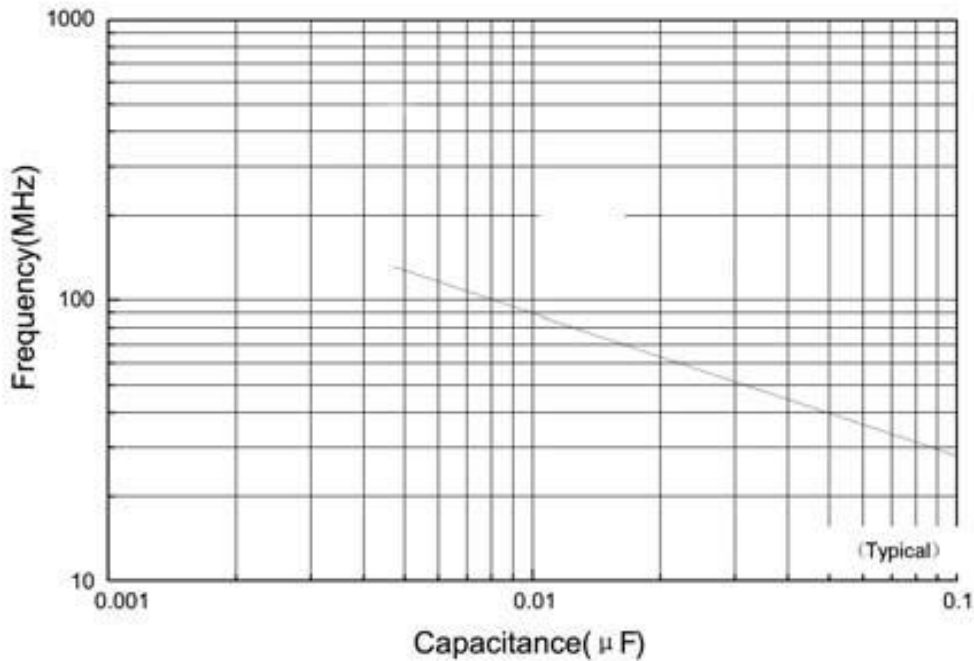

≠ Mounting Pad Recommendations

Orientation	A Min	B Min	C Min	D Min
Vertical	0.120"	0.050"	0.075"	0.175"
Horizontal	0.130"	0.050"	0.075"	0.175"

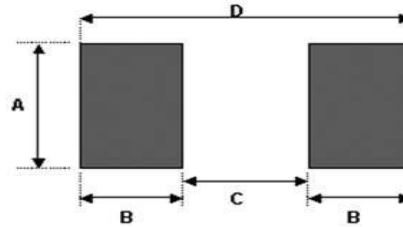

≠ Tape & Reel Specifications (mm)

Horizontal Orientation

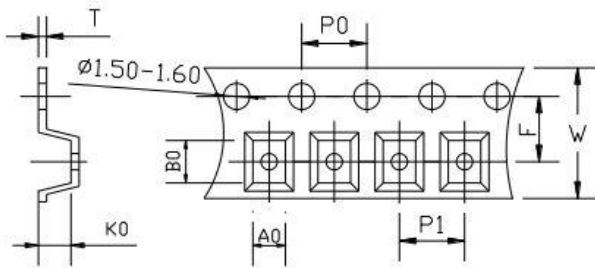

Orientation	W	P0	P1	T	F	Qty Min	Qty/reel	Tape Material
Horizontal	8.00	4.00	4.00	0.22	3.50	500	3000	Plastic

A₀ B₀ K₀

- Determined by component size. Typical clearance between the cavity and the component is:
.05 (.002) min to .50 (.020) max for 8mm tape and .50 (.002) min to .65 (.026) max for 12mm tape.
- The component cannot rotate more than 20° within the determined cavity.



X7R RF By-Pass Capacitors

2225X (0.220" x 0.250")

≠ Product Features

- High Q
- High RF Current/Voltage
- Ultra Stable Performance
- Capacitance Range:
10nF to 1μF

≠ Product Applications

Typical Functional Applications:

- Tuning • Bypass • Coupling
- D.C. Blocking • Impedance Matching

Typical Circuit Applications

- UHF/Microwave RF Power Amplifiers
- Antenna Tuning • Plasma Chambers
- Medical Equipment



≠ Part Numbering

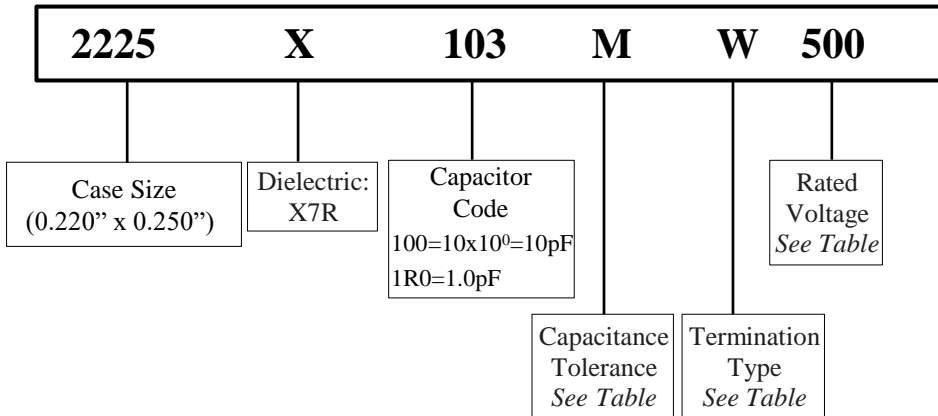

≠ Capacitor Dimensions

Unit: inch (millimeter)

Length	Width	Thickness	Overlap
Lc	Wc	Tc	B
0.230+0.020 ~ -0.012 (5.84+0.51 ~ -0.30)	0.250 ± 0.015 (6.35 ± 0.38)	0.165 (4.19 max)	0.030 ± 0.015 (0.762 ± 0.380)

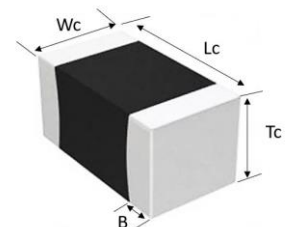



≠ 2225X Capacitance Values

Cap. uF	Cap Code	Tol.	Rated WVDC	Cap. uF	Cap Code	Tol.	Rated WVDC	Cap. uF	Cap Code	Tol.	Rated WVDC
0.010	103	K,M	300V	0.082	823	K,M	200V	0.560	564	K,M	150V
0.012	123			0.100	104			0.680	684		
0.015	153			0.120	124			K,M	100V		
0.022	223			0.150	154						
0.033	333	K,M	250V	0.220	224	K,M	150V				
0.047	473			0.330	334						
0.068	683			0.470	474						

Special capacitances, tolerances and WVDC are available. Please contact PPI.

≠ Capacitance Tolerance Codes

Code	K	M
Tol.	±10%	±20%

≠ Termination Types

Termination Code	Plated Material
W	Sn/Ni
L	90% Sn10%Pb
P (Non-Magnetic)	Sn/ Cu
C	Ag/Pb
G	Au/Ni

Note: "Non-Magnetic" means no magnetic materials.

≠ Voltage Codes

Voltage	Code
100V	101
150V	151
200V	201
250V	251
300V	301

≠ Electrical Specifications

Operating Temperature Range	-55°C to +125°C
Insulation Resistance (IR)	Insulation Resistance @ +25°C > 1000ΩF Insulation Resistance @ +125°C > 100ΩF
Temperature Voltage Coefficient	± 15% Maximum
Dielectric Withstanding Voltage (DWV)	2.5x WVDC, 5 seconds
Max Dissipation Factor	0.025 (2.5%) max
Test Parameters	1kHz, 1.0 VRMS, 25°C



X7R RF By-Pass Capacitors

2225X (0.220" x 0.250")

Q vs. Frequency

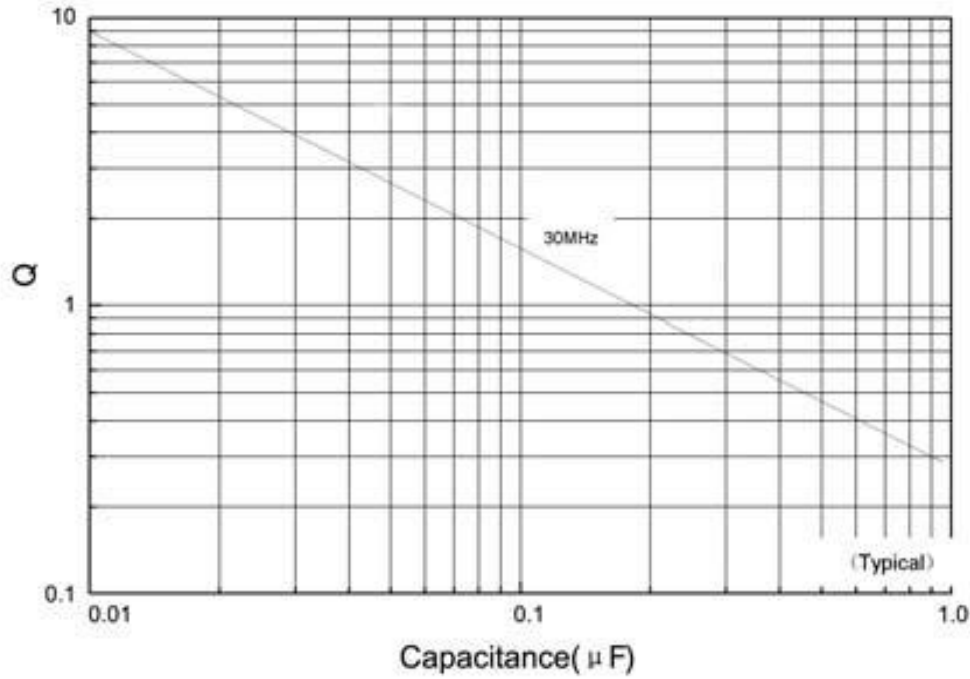

Current Rating vs. Capacitance

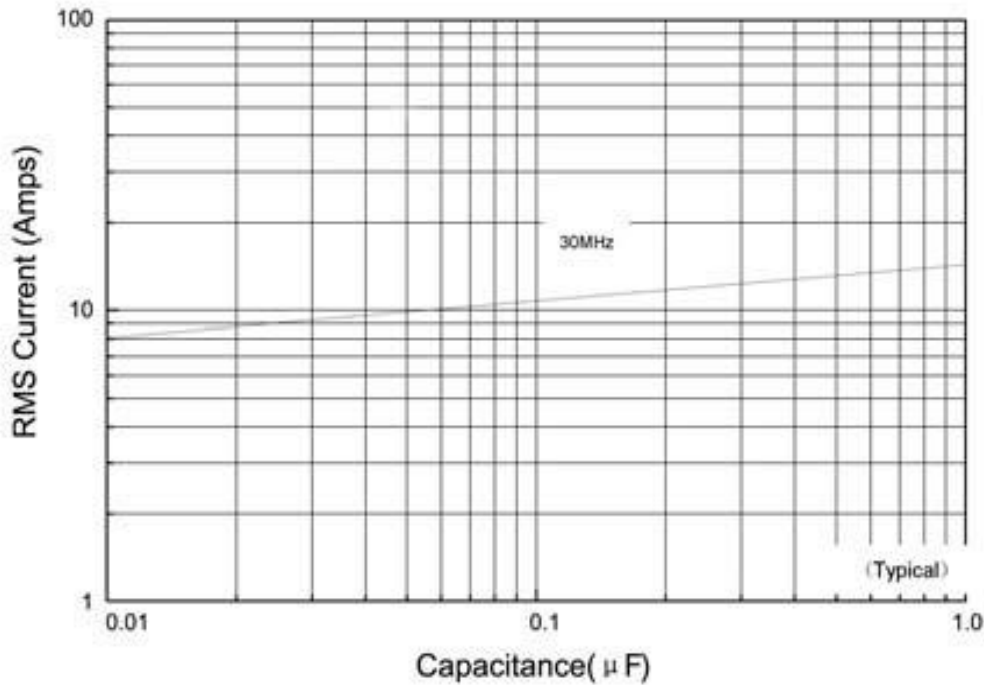

≠ ESR vs Capacitance

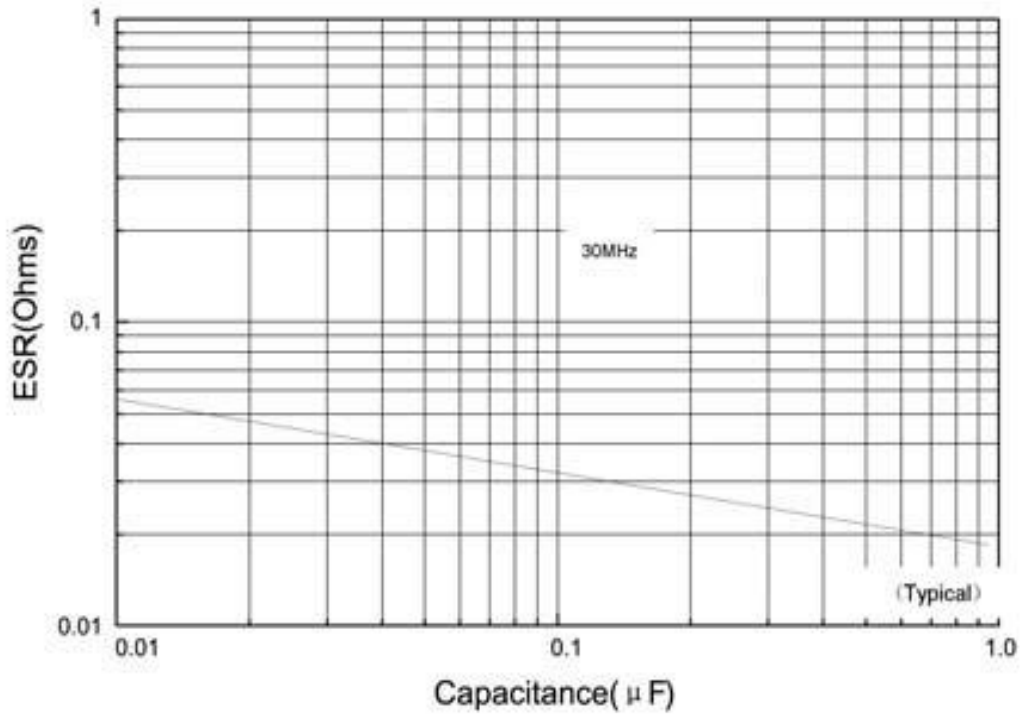

≠ Series Resonance vs. Capacitance

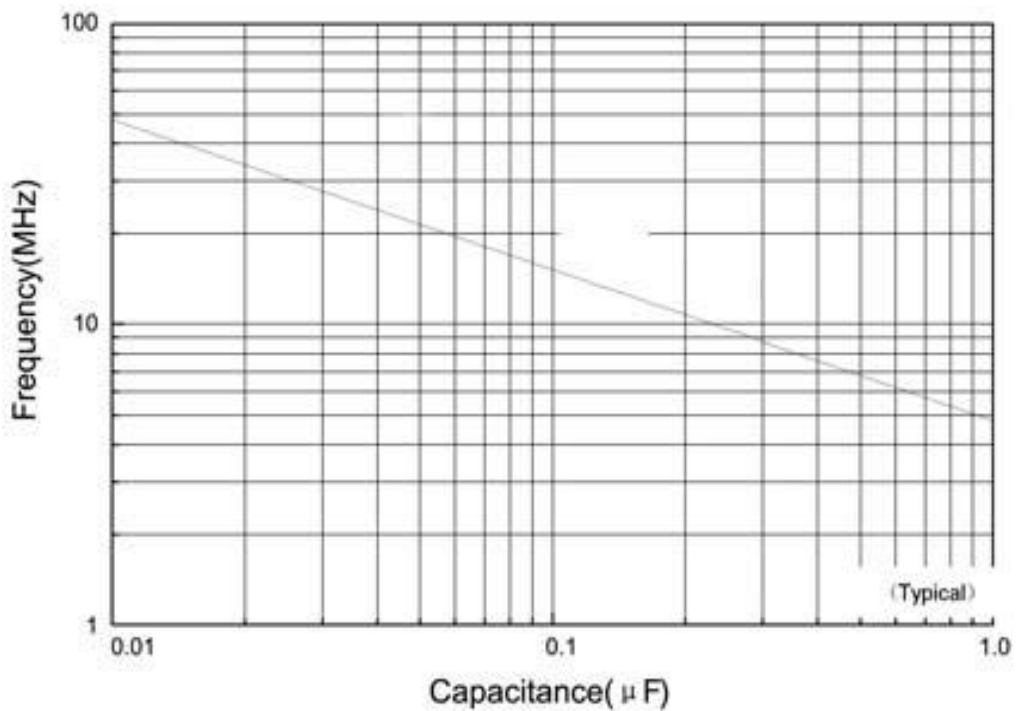

≠ Mounting Pad Recommendations

Orientation	A Min	B Min	C Min	D Min
Horizontal	0.280"	0.050"	0.200"	0.300"

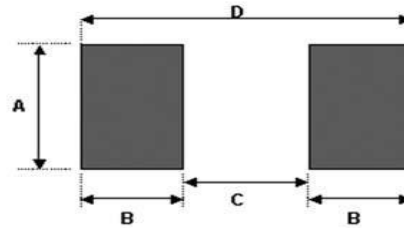

≠ Tape & Reel Specifications (mm)

Horizontal Orientation

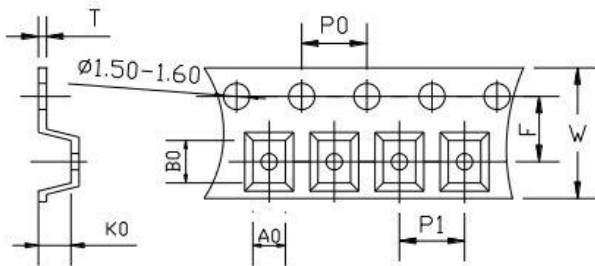

Orientation	W	P0	P1	T	F	Qty Min	Qty/reel	Tape Material
Horizontal	8.00	4.00	4.00	0.22	3.50	500	3000	Plastic

A₀ B₀ K₀

- Determined by component size. Typical clearance between the cavity and the component is:
.05 (.002) min to .50 (.020) max for 8mm tape and .50 (.002) min to .65 (.026) max for 12mm tape.
- The component cannot rotate more than 20° within the determined cavity.

≠ Hand Soldering Chip Capacitors

Among the most common reasons multilayer ceramic chip capacitors (MLCCs) fail is improper hand soldering to printed circuit boards. Typically, one or more hairline cracks develop in the ceramic, defects that may even have an imperceptible effect on initial performance, but that manifest with time, circuit board flexure, or temperature excursions. Herein are a few tips, suggestions, and caveats to be aware of in performing a reliable hand soldering attachment.

Solders. Before selecting a solder, one should know the metallization on the chip. Starting at the component ceramic surface from which the electrodes protrude (typically < 1 mil), a contacting “termination” is applied that most often contains silver (Ag) or nickel (Ni). Over this is plated a barrier metal, typically nickel or copper (for non-magnetic applications), followed by a finishing metallization of tin (Sn) or lead (Pb)-tin. Other finishes may include palladium- silver (Pd/Ag), Ag, or gold (Au).

For finishes that include Ag, a silver bearing solder such as Sn62 is recommended to combat leaching of the component’s silver into the solder joint. Silver bearing solders also improve resistance to thermal fatigue. For finishes that include Au, a solder such as In50 is suggested to avoid gold scavenging that may cause embrittlement (which occurs when gold comprises approximately 3% or greater by weight of the solder joint). For finishes that do not contain noble metals, SN63 is often used, or Sn95.5 or Sn96 where there is a no-lead, e.g. ROHS, requirement.

Fluxes. An appropriate flux helps to clean the surfaces to be soldered and facilitates solder spread; it may also remove oxidation. Check with the solder manufacturer for a recommended flux. Rosin based fluxes are most common but require post solder cleaning.

Fluxes are available both separately as pastes and as internal cores within wire solder. Each form has advantages and disadvantages. Use of an external flux permits precise placement in exact quantities, but consideration must be given to the activation temperature of the flux, which will be lower than that of the solder liquidus, and the time spent at this temperature. Too long at the latter will result in boiling off the flux and reducing its effectiveness. Flux core solder is easy and convenient to use but may require more solder than desirable to have sufficient flux for good coverage.

In practice, external flux seems to work best for parts of size 0603 or 0505 and below, while flux core solder appears satisfactory for larger component sizes.

Soldering iron. A temperature-controlled iron of suitable wattage is strongly recommended. The iron temperature should typically be set 20-30°C above the solder liquidus temperature. Tip size is important; it should be about the same size as the part. Too small a tip (corresponding to an iron of insufficient wattage) will take too long to heat the printed circuit board land and part, while too large a tip (too high a wattage iron) may damage the board or component.

⚡ Soldering Procedure

The initial consideration is which end of the capacitor to solder first. The choice can generally be decided by recognizing that it is desirable to minimize the heat flowing directly through the component. Thus, it is best to start from the end that has the poorest heat conduction (equals highest thermal resistance) to a heat sink. (Were one to start from the opposite end, a good heat path would have been created through the capacitor to the heat sink when one soldered the second joint.) If it is not apparent which land has the poorer connection to a heat sink, begin with the one having the smallest area.

Follow these steps in soldering:

1. Pre-heat the substrate. Where possible, it is very desirable to gradually pre-heat the substrate, e.g. on a hotplate, to about 30°C below the solder liquidus temperature. Two steps are usually sufficient: Start the hotplate at a temperature about halfway to the desired pre-heat temperature, place the board on it and wait till the board temperature stabilizes, then increase the hotplate temperature to the desired final pre-heat value.
2. Pre-“tin” the traces. Select one of the PC board lands and clean it with isopropyl alcohol. If the solder you are using does not contain its own flux, place a small quantity of flux on the land, and a small amount of solder into the flux. (A razor may be used to cut a tiny custom preform from solid wire.) Place the iron on the printed circuit trace adjacent to the flux (but not touching) and heat the land until the solder melts into a flat, shallow pool. Remove the iron, then clean off any remaining flux with isopropyl alcohol. Repeat the procedure for the second land, then add fresh flux and a fresh solder preform (if not using flux-core solder) to each tinned land. (The preform should have sufficient mass to create a proper fillet – see step 5 – on the component.)
3. Pick up the component with either a hand tweezer or vacuum tweezer. (Stainless steel or ceramic-tipped tweezers are preferred.)
4. Place the component so that it straddles the circuit board lands, and make sure it lies flat on the board. As shown in **Fig. 1**, **Do not touch the component directly with the soldering iron.** Rather, touch the iron to the land adjacent to the capacitor until the solder begins to flow; then move the iron slowly toward the component.

Fig. 1

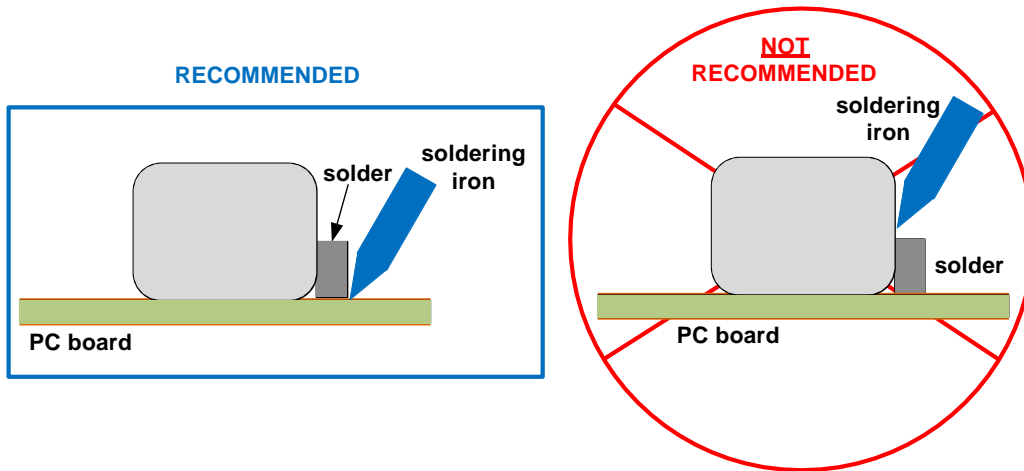

5. When a fillet forms, remove the iron. As shown in **Fig. 2**, solder fillets should occupy about 25-40% of the component's height, have a concave profile, and be free of peaks and voids.

6. Repeat steps 1-5 for the second joint, then let the board cool gradually to room temperature. Use isopropyl alcohol to remove any residual flux from each joint.

Fig. 2

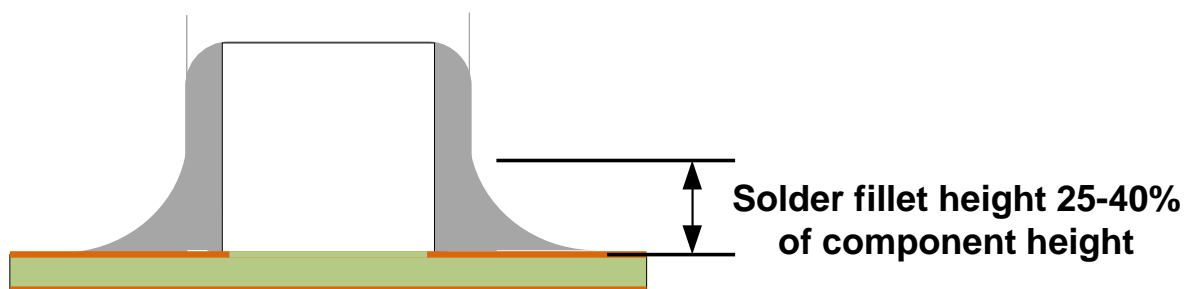

≠ Wave Soldering

When sudden heat is applied to the elements, the mechanical strength of the components should decrease because remarkable temperature change can cause deformity of components inside. Also, long soldering time or high soldering temperatures, result in leaching by the external electrodes, causing poor adhesion or a reduction in capacitance value due to loss of contact between electrodes and end termination.

In order to avoid mechanical damage in the elements, preheating should be requested for both of the components and the PCB board. Preheating conditions are given in the table below. It is requested to keep the temperature gap between the soldering and the elements surface (.T) as small as possible.

When elements are submerged in solvent after mounting, be sure to maintain the temperature gap (.T) between the element and solvent within the range shown in the table below.

Do not apply the flow soldering to capacitors not listed in the table below.

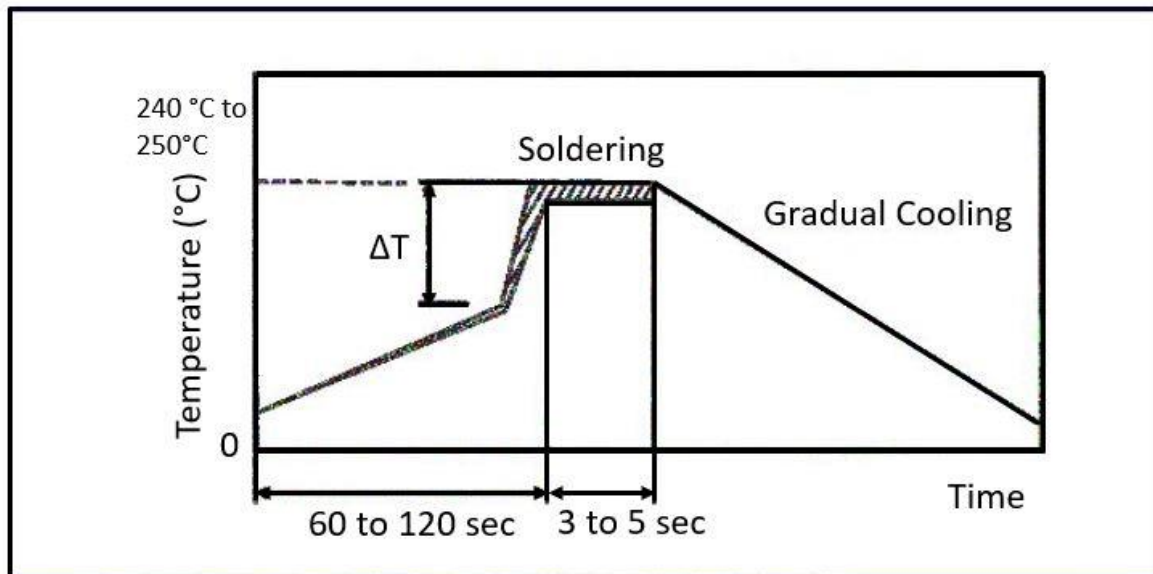



Chip Capacitor	01005/0201/0402/0603/0505/0805
Preheating	$\Delta T \leq 150^\circ\text{C}$

PPI does not recommend flow soldering for its 1111P/1111C, 2225P/2225C, 3838P/3838C.

≠ Soldering Iron

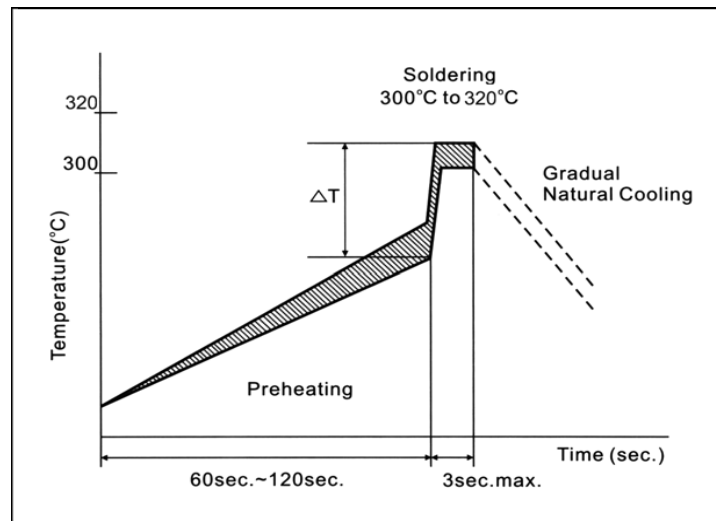
When sudden heat is given to the elements by soldering iron, the mechanical strength of the components should weaken because sharp temperature change can cause deformity of components inside. In order to avoid mechanical damage in the elements, preheating should be requested for both of the components and the PCB board. Preheating conditions are given in the below table. It is requested to keep the temperature gap between the soldering and the elements surface (ΔT) as small as possible. After the soldering, it should not be allowed to cool down suddenly.

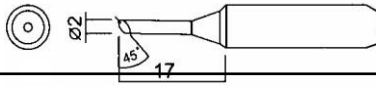
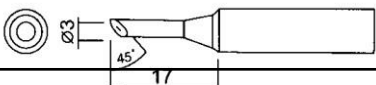

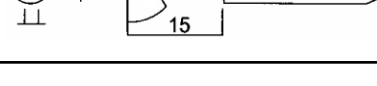
Size	Soldering Iron	Temperature	Soldering Iron head Size	Solder
0505/0805	70W Thermostat Iron	330°C		63Sn/37Pb, 95.5Sn/3.8Ag /0.7Cu
1111		350°C		
2225		370°C		
3838		370°C		

≠ Hi-Q Low ESR Capacitor Tape & Reel Specifications

Case Size	Orientation *	A0	B0	K0	W	P0	P1	T	F	Minimum Qty per Reel	Std Qty per Reel	Tape Material
0201N	H	0.406	0.749	0.422	8.00	4.00	2.00	0.42	3.50	500	500	Paper
0402N	H	0.60	1.10	1.00	8.00	4.00	2.00	0.20	3.50	500	500	Paper
0603N	H	0.95	1.80	0.85	8.00	4.00	4.00	0.20	3.50	500	500	Paper
0805N	H	1.60	1.60	2.40	8.00	4.00	4.00	0.20	3.50	500	500	Paper
1111N	H	2.92	3.51	2.34	8.00	4.00	4.00	0.254	3.50	500	500	Plastic
1111N	V	2.30	3.55	2.70	12.00	4.00	4.00	0.30	5.50	500	500	Plastic
0505CP	H	1.38	1.68	0.98	8.00	4.00	4.00	0.22	3.50	500	3000	Plastic
0505CP	V	1.10	1.60	1.40	12.00	4.00	4.00	0.30	5.50	500	2000	Plastic
1111CP	H	2.85	3.50	1.95	8.00	4.00	4.00	0.22	3.50	500	2000	Plastic
1111CP	V	2.00	3.50	2.70	12.00	4.00	4.00	0.40	5.50	500	1500	Plastic
2225CP	H	6.70	6.20	3.40	16.00	4.00	12.00	0.30	7.50	500	500	Plastic
3838CP	H	10.10	10.10	3.30	16.00	4.00	16.00	0.30	7.50	50	200	Plastic
0505X	H	0.042	0.065	0.054	8.00	4.00	4.00			500	4000	Plastic
1111X	H	0.109	0.131	0.091	8.00	4.00	4.00	0.22	3.50	500	2000	Plastic
2225X	H	0.270	0.235	0.128	12.00	4.00	4.00			500	500	Plastic

*H = Horizontal
V = Vertical

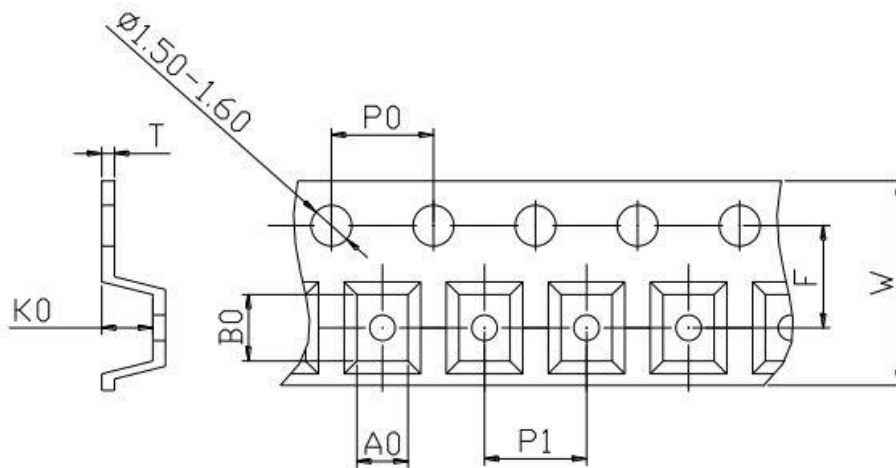

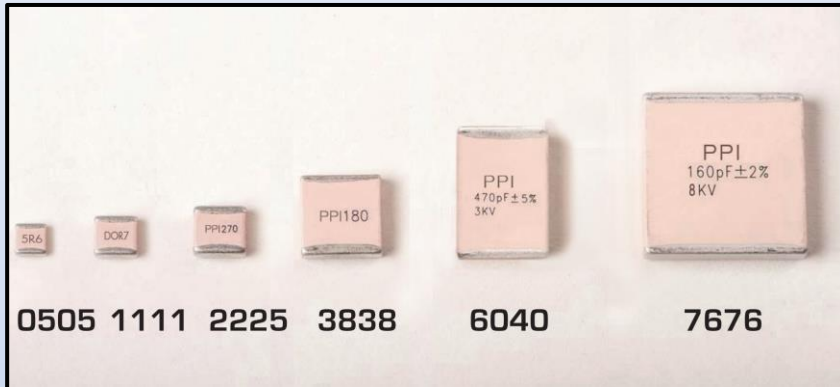

Marking shown for illustration purposes only.
Actual marking may differ.

